



**HPRC**<sup>®</sup>

**HPRC**

2550W

**2017**

CASES WORKBOOK

H P R C C A S E S  
**MADE IN ITALY**  
M A N U F A C T U R E D



**HPRC®**

### **Our Brand**

We're about happiness by cases. It means we're not just in the business of creating protective cases, even though that is what we do. Our everyday commitment is designed to make people happy.

From an ever-growing collection of innovative products to our passionate team who makes it happen, it's all about happiness.

### **Our Products**

We're always looking for what's next. We're constantly innovating our original designed form and function, proving a fresh approach to the art of cases. By incorporating different styles, top quality materials and eye-catching patterns into our design, we make more than a case. We make a statement.

### **Our History**

HPRC cases were born in 2006 with one simple premise: we can design a better case. In almost 10 years HPRC has grown into a successful international business, teaming up with important companies and partners. Our products can be found in 76 countries and have garnered top awards and praise. As we grow, our entrepreneurial spirit continues to drive the HPRC culture. After all, it's what helped us build one of the world's best hard cases brand.

# Ultralight. Watertight. Smart Cases.

HPRC cases can be used for all sorts of applications and different areas: photography, industrial, military, nautical, police and many others. HPRC provides total protection to the carried equipment against dust, water, impacts and corrosion for chemical agents.



Outdoor | Diving | Marine



Photo | Video







Industrial | Electronic | It



Photo by Luigi Freni

Military | Government



Photo by Flavio Oliva

Fire | Emergency | Medical

# Highlights

## 2017

### HPRC2550W

V.2017



The new **HPRC2550W** is the upgrade to our most popular case.

- Now added FLAT top handle
- Improved Trolley System with one-handed thumb release
- Customizable wheel hubs (logos/colors)
- New wider latched with Soft-Touch overmold
- New and improved Valance



**More info at page: 26**

### SECOND SKIN



Second Skin is the new and revolutionary protective system thought by **HPRC** to protect your equipment;



Like a real "second skin" it's made by a thermoforming material that allows you to exploit the maximum internal volume of the case maintaining an optimal protection. A system that increases the 20% the internal usable

volume, with 70% weight less than the current soft deck. Second Skin weighs only 350 grams and, thanks to the modular dividers, you can always create different configurations according to your needs.

# Special soft cases

---

---

HPRC also produces different lines of soft cases and backpacks specifically designed to carry and protect the most popular drones of the market.



# Committments

## Our committment to you:

**1.UNDERSTAND** the problems of your market and your specific requirements. Through our expert knowledge of technological and economic trends we can offer an uncompromisingly individual approach to each customer.

**2.FIND** a transport solution tailored to your requirements. Our extensive cases range, our custom solutions that go far beyond our product offer, our team that assists you in selecting the case that is best suited to your own needs, are our core strengths.

**3.LISTEN** to and take account of your comments, through our network of experts and our frequent satisfaction surveys.

**4.BE** incessantly innovative and competitive in the professional cases market.



# HPRC: innovation, technology and design.

Most of hard watertight cases are made in standard pp: our r&d department has developed an enhanced compound, still based on pp, now balanced with additional high performance resins. Ttx01® allows to produce cases which are lighter in weight and stronger in robustness. The special mix we added makes the HPRC shell thinner and more elastic, increasing therefore the shockproof degree and the lightweight. On the top of that, maintaining pp characteristics, HPRC cases are acidproof, scratchproof, able to resist to extreme weather conditions and temperature changes (all products are tested from - 40° c up to 80°c).



pole: ALU



body: TTX01® hardware: steel



wheels: PA66+PUR



handle: PP+SEBS



latches: POM



ext.handle: PA66GF30

Do you want to know more?  
Please contact our technical team: [tech@hprc.it](mailto:tech@hprc.it)



**HPRC life time warranty:** HPRC products have been built to rigorous standards of quality and are guaranteed against all defects in materials and workmanship for the whole life of the case.



**Airex** is the new automatic purge valve that is auto press release adjusted to changing environments automatically.

The attention and respect toward the environment and the commitment to an eco-sustainable future are important values for HPRC

 we case in **green.**

Our commitment starts from the design phase of the product, and involves all the production stages including the management of the impact of the product's end of life. All shells and components of HPRC cases are 100% recyclable: the production and transformation discards are infact reintegrated in the production cycle. The high resistance of the patented material ttx01® allows to use the HPRC cases longer than any other case, reducing therefore the emissions of CO2 due to the production

and distribution. The constant quest for suppliers complying with iso 14000 or emas certification and which are geographically close to our company is a contribute to reduce the environmental impact and represents a challenge in a world where firms usually aim only for low price suppliers not considering their possibly higher environmental impact. Moreover HPRC adopts renewable sources plants for energy production to cover the energetic needs.



# Standard cases

HPRC cases are available with a standard setup if you don't need any special customization regarding the shell or the interior foam. Here are the 5 possible standard configurations.

\* CUBED FOAM - USA: F



\* EMPTY - USA: E



\* SOFT PADDED OPEN DECK + DIVIDERS - USA: DK



\* INTERIOR BAG - USA: IC



\* SECOND SKIN - USA: SK



\* PANEL FRAME MOUNTING SYSTEM AVAILABLE

# Oem cases

We are cases producers,  
if you do not find the right size or best liked design  
we will make a customized case for you

1. Product inquiry >>>> Mold + price offer
2. Contract signing >>>> Design drawing
3. Client confirmation >>>> Mold making
4. Sample checking >>>> Production arrangement



377

3400

4

103

54

105

1.5

# Custom fit cases

Customization concerns: color, printing, adhesive, foam inlay (die cut, water cut, milled, moulded), thermoformed inlay, lid panels and organizer, extra working on the cases shell (holes, external applications) keeping the water tightness.



## HIGH VISIBILITY INLAYS

A special high visibility inlay can be designed in order to avoid forgetting equipment on the field after use.



## CUSTOMIZED LAYOUT

We give customers different equipment layouts options in order to optimize space and handiness.



### CUSTOMIZED COVERS

Customization also includes the possibility to design solutions in order to use the cover as a glove compartment. We can provide organizers, special tools addition, shell modifications and custom colors.



### SHELL CUSTOMIZATION

HPRC customization service also provides shell customization, including holes for external connections.

HPRC panel frame accessory (HPRCPF) allows customers to install a control panel into the case, ensuring a perfect fit.



### INJECTION INLAYS

The custom inlay made in expanded polypropylene of different densities guarantees a perfect protection and a professional look to the case. Our service includes the initial study of the mould and goes through the prototype phase and final production.



### MILLED FOAMS

The milling technology allows to get one piece inlays with many different depths.



### WATER CUTTING TECHNOLOGY FOAMS

Expanded polyethylene foams are available in various densities (Kg/m<sup>3</sup>), resistance to compression (kPal) and resistance to different temperatures ranges (°C). These foams, produced with water cutting technology, guarantee a good protection and allow a wide range of customizations.



### MULTY LAYER

A multi layer case is a handy solution, especially when equipment is made of many small and different parts that must be stored and protected into one case only.



# HPRC 1100



\* open cases images reflect the different HPRC cases internal options

## TECHNICAL FEATURES

### Dimension:

internal dimension 57x58x25,5(mm) - 2.24x2.28x1.00(in)  
external dimension 69x80x32(mm) - 2.72x3.15x1.26(in)

lid: 12,8(mm) - 0.50(in) bottom: 12,7(mm) - 0.50(in)

### Weight:

empty: 0,04kg - 0.09lbs

available empty or with memory card storage

### Temperature rating:

Minimum Maximum  
-40°C -40°F +80°C +176°F

### Colors:

Black - Ferrari red



## TECHNICAL DRAWING

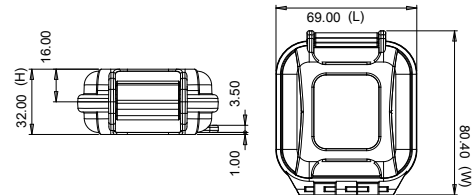

<p>* memory card case</p>	<p>* empty case</p>		<p><b>APPROVALS</b> ATA 300 IP67 STANAG 4280 DS 81-41</p> <p><b>TEST</b> DROP IMPACT HANDLE WATERTIGHT INTEGRITY UV COLOR AND MATERIAL PROTECTION</p> <p>volume in litres wheeled</p>

## FEATURES

- Removable multiformat memory card holder
- Accepted card Formats: SD, Memory stick, Memory stick pro duo, Mini SD
- Holds up to 2 memory cards per format
- Full/empty indicator



\* open cases images reflect the different HPRC cases internal options



## TECHNICAL FEATURES

### Dimension:

internal dimension 116x67x25,5(mm) - 4.57x2.64x1.00(in)  
external dimension 127x90x32(mm) - 5.00x3.54x1.26(in)

lid: 12,8(mm) - 0.50(in) bottom: 12,7(mm) - 0.50(in)

### Weight:

empty: 0,09kg - 0.19lbs

**available empty or with memory card storage**

### Temperature rating:

Minimum Maximum  
-40°C -40°F +80°C +176°F

### Colors:

Black - Ferrari red



## TECHNICAL DRAWING

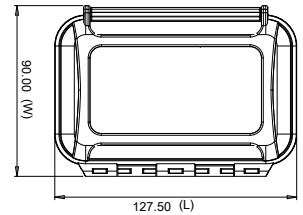
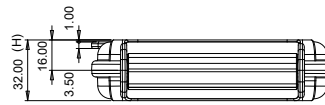

\* cubed foam



\* memory card case



\* memory Card Case for video



**APPROVALS**  
ATA 300  
IP67  
STANAG 4280  
DS 81-41

**TEST**  
DROP  
IMPACT  
HANDLE  
WATERTIGHT INTEGRITY  
UV COLOR AND MATERIAL  
PROTECTION



## FEATURES

- Removable multiformat memory card holder
- Accepted card Formats: SD, Memory stick, Memory stick pro duo, Mini SD
- Holds up to 2 memory cards per format
- Full/empty indicator



# HPRC 2100



\* open cases images reflect the different HPRC cases internal options

## TECHNICAL FEATURES

### Dimension:

internal dimension 210x145x94(mm) - 8.27x5.71x3.70(in)  
external dimension 235x196x110(mm) - 9.25x7.72x4.33(in)



lid: 18(mm) - 0.71(in) bottom: 76(mm) - 2.99(in)

### Weight:

empty: 0,76kg - 1.68lbs  
with cubed foam: 0,84kg - 1.85lbs

### Temperature rating:

Minimum Maximum  
-40°C -40°F +80°C +176°F

### Colors:

Black - Orange - Ferrari red - Electric blue

## TECHNICAL DRAWING

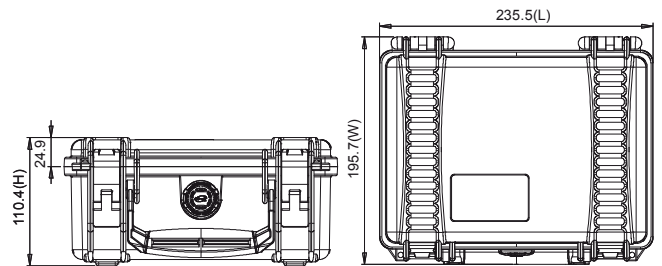

\* cubed foam



\* interior bag



**APPROVALS**  
ATA 300  
IP67  
STANAG 4280  
DS 81-41

**TEST**  
DROP  
IMPACT  
HANDLE  
WATERTIGHT INTEGRITY  
UV COLOR AND MATERIAL  
PROTECTION



## ACCESSORIES

**HPRCCUB2100**  
CUBED FOAM  
USA:HPRCFO (foam only)



**HPRCLO708TSA-1**  
PADLOCK - TSA



**HPRCBAG2100**  
INTERIOR BAG  
USA:HPRCIC (internal case)



**HPRCPF-001-01**  
PANEL FRAME  
(panel not included)



\* open cases images reflect the different HPRC cases internal options



## TECHNICAL FEATURES

### Dimension:

internal dimension 236x182x108(mm) - 9.29x7.17x4.25(in)  
external dimension 258x230x123(mm) - 10.16x9.06x4.84(in)



lid: 29(mm) - 1.14(in) bottom: 79(mm) - 3.11(in)

### Weight:

empty: 0,87kg - 1.92lbs  
with cubed foam: 1,08kg - 2.38lbs

### Temperature rating:

Minimum -40°C -40°F      Maximum +80°C +176°F

### Colors:

Black

## TECHNICAL DRAWING

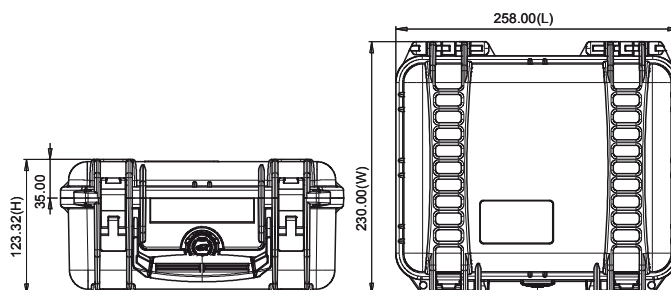

\* cubed foam



\* interior bag



**APPROVALS**  
ATA 300  
IP67  
STANAG 4280  
DS 81-41

**TEST**  
DROP  
IMPACT  
HANDLE  
WATERTIGHT INTEGRITY  
UV COLOR AND MATERIAL  
PROTECTION



## ACCESSORIES

**HPRCCUB2200**  
CUBED FOAM  
USA:HPRCFO (foam only)



**HPRCL0708TSA-1**  
PADLOCK - TSA



**HPRCBAG2200**  
INTERIOR BAG  
USA:HPRCIC (internal case)



**HPRCPF-002-01**  
PANEL FRAME  
(panel not included)



# HPRC 2250



## TECHNICAL FEATURES

### Dimension:

internal dimension 236x182x155(mm) - 9.29x7.17x6.10(in)  
external dimension 258x230x170(mm) - 10.16x9.06x6.69(in)



lid: 29(mm) - 1.14(in) bottom: 126(mm) - 4.96(in)

### Weight:

empty: 1,00kg - 2.20lbs  
with cubed foam: 1,35kg - 2.97lbs

### Temperature rating:

Minimum Maximum  
-40°C -40°F +80°C +176°F

### Colors:

Black

## TECHNICAL DRAWING

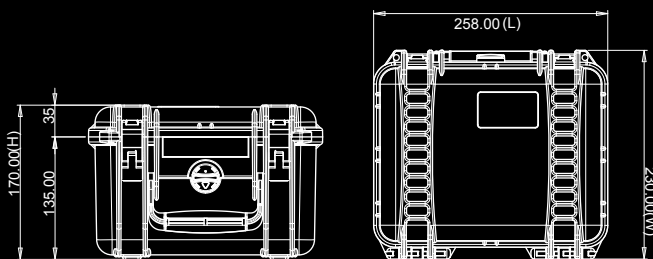

\* cubed foam



\* interior bag



**APPROVALS**  
ATA 300  
IP67  
STANAG 4280  
DS 81-41

**TEST**  
DROP  
IMPACT  
HANDLE  
WATERTIGHT INTEGRITY  
UV COLOR AND MATERIAL  
PROTECTION

lit 7 volume in litres



## ACCESSORIES

**HPRCCUB2250**  
CUBED FOAM  
USA:HPRCFO (foam only)

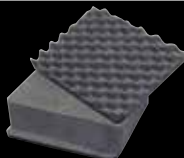

**HPRCLO708TSA-1**  
PADLOCK - TSA



**HPRCBAG2250**  
INTERIOR BAG  
USA:HPRCIC (internal case)



**HPRCPF-002-01**  
PANEL FRAME  
(panel not included)



\* open cases images reflect the different HPRC cases internal options



## TECHNICAL FEATURES

### Dimension:

internal dimension 304x231x137(mm) - 11.97x9.09x5.39(in)  
external dimension 335x289x155(mm) - 13.19x11.38x6.10(in)



lid: 31(mm) - 1.22(in) bottom: 106(mm) - 4.17(in)

### Weight:

empty: 1,67kg - 3.68lbs  
with cubed foam: 1,90kg - 4.19lbs

### Temperature rating:

Minimum Maximum  
-40°C -40°F +80°C +176°F

### Colors:

Black - Orange - Ferrari red - Electric blue

## TECHNICAL DRAWING

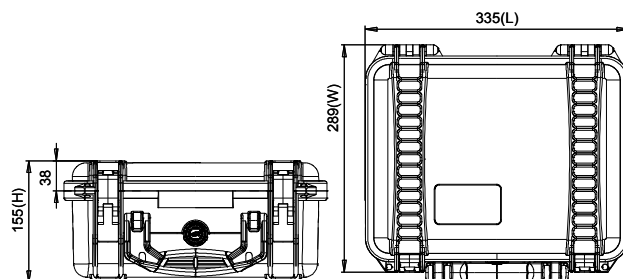

\* cubed foam



\* interior bag



**APPROVALS**  
ATA 300  
IP67  
STANAG 4280  
DS 81-41

**TEST**  
DROP  
IMPACT  
HANDLE  
WATERTIGHT INTEGRITY  
UV COLOR AND MATERIAL  
PROTECTION



## ACCESSORIES

**HPRCCUB2300**  
CUBED FOAM  
USA:HPRCFO (foam only)



**HPRCLO708TSA-1**  
PADLOCK - TSA



**HPRCBAG2300**  
INTERIOR BAG  
USA:HPRCIC (internal case)



**HPRCPF-003-01**  
PANEL FRAME  
(panel not included)





# HPRC 2350



\* open cases images reflect the different HPRC cases internal options

## TECHNICAL FEATURES

### Dimension:

internal dimension 340x235x99(mm) - 13.38x9.25x3.90(in)  
external dimension 365x290x115(mm) - 14.37x11.42x4.53(in)



lid: 29(mm) - 1.14(in) bottom: 70(mm) - 2.75(in)



### Weight:

empty: 1.48kg - 3.25lbs  
with cubed foam: 1.66kg - 3.65lbs

### Temperature rating:

Minimum -40°C -40°F Maximum +80°C +176°F

### Colors:

Black

## TECHNICAL DRAWING

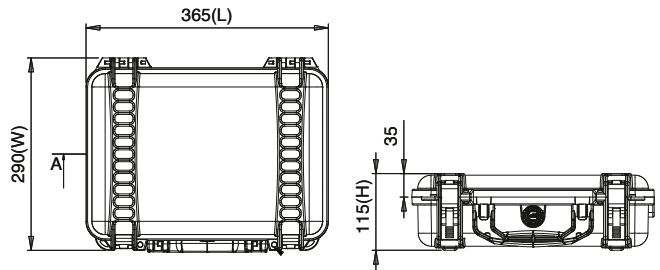

\* cubed foam



### APPROVALS

ATA 300  
IP67  
STANAG 4280  
DS 81-41

### TEST

DROP  
IMPACT  
HANDLE  
WATERTIGHT INTEGRITY  
UV COLOR AND MATERIAL  
PROTECTION



## ACCESSORIES

**HPRCCF2350**  
CUBED FOAM  
USA:HPRCFO (foam only)

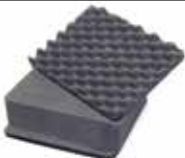

**HPRCLO708TSA-1**  
PADLOCK - TSA



**HPRCBAG2350**  
INTERIOR BAG  
USA:HPRCIC (internal case)





# HPRC 2400



\* open cases images reflect the different HPRC cases internal options

## TECHNICAL FEATURES

### Dimension:

internal dimension 380x266x152(mm) - 14.96x10.47x5.98(in)  
external dimension 405x330x170(mm) - 15.94x12.99x6.69(in)



lid: 45(mm) - 1.77(in) bottom: 107(mm) - 4.21(in)

### Weight:

empty: 2,05kg - 4.52lbs  
with cubed foam: 2,38kg - 5.25lbs



### Temperature rating:

Minimum Maximum  
-40°C -40°F +80°C +176°F

### Colors:

Black - Orange - Ferrari red - Electric blue

## TECHNICAL DRAWING

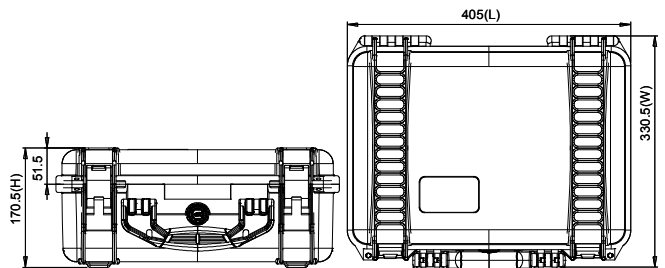

\* cubed foam



\* interior bag



**APPROVALS**  
ATA 300  
IP67  
STANAG 4280  
DS 81-41

**TEST**  
DROP  
IMPACT  
HANDLE  
WATERTIGHT INTEGRITY  
UV COLOR AND MATERIAL  
PROTECTION



## ACCESSORIES

<p><b>HPRCCUB2400</b> CUBED FOAM USA:HPRCFO (foam only)</p> 	<p><b>HPRCLO708TSA-1</b> PADLOCK - TSA</p> 	<p><b>HPRCBAG2400</b> INTERIOR BAG USA:HPRCIC (internal case)</p> 	<p><b>HPRCORG2400</b> LID ORGANIZER</p> 	<p><b>HPRCPF-004-01</b> PANEL FRAME (panel not included)</p> 
--	--	---	---	---



\* open cases images reflect the different HPRC cases internal options



## TECHNICAL FEATURES

### Dimension:

internal dimension 409x306x175(mm) - 16.10x12.05x6.89(in)  
external dimension 434x371x193(mm) - 17.09x14.61x7.60(in)



lid: 70(mm) - 2.76(in) bottom: 105(mm) - 4.14(in)

### Weight:

empty: 2,60kg - 5.73lbs  
with cubed foam: 3,14kg - 6.92lbs

### Temperature rating:

Minimum -40°C -40°F      Maximum +80°C +176°F

### Colors:

Black

## TECHNICAL DRAWING

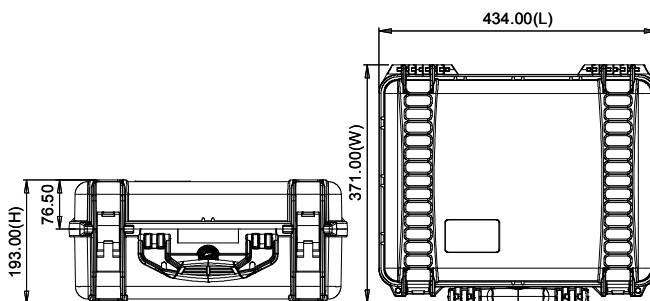

\* cubed foam



\* interior bag



**APPROVALS**  
ATA 300  
IP67  
STANAG 4280  
DS 81-41

**TEST**  
DROP  
IMPACT  
HANDLE  
WATERTIGHT INTEGRITY  
UV COLOR AND MATERIAL  
PROTECTION

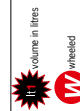

## ACCESSORIES

**HPRCCUB2460**  
CUBED FOAM  
USA:HPRCFO (foam only)



**HPRCLO708TSA-1**  
PADLOCK - TSA



**HPRCBAG2460**  
INTERIOR BAG  
USA:HPRCIC (internal case)



**HPRCORG2460**  
LID ORGANIZER



**HPRCPF-005-01**  
PANEL FRAME  
(panel not included)



# HPRC 2500



## TECHNICAL FEATURES

**Dimension:**  
 internal dimension 450x323x175(mm) - 17.72x12.72x6.89(in)  
 external dimension 478x390x194(mm) - 18.82x15.35x7.64(in)



lid: 46(mm) - 1.81(in) bottom: 129(mm) - 5.08(in)



**Weight:**  
 empty: 3,15kg - 6.94lbs  
 with cubed foam: 3,71kg - 8.18lbs

**Temperature rating:**  
 Minimum -40°C -40°F      Maximum +80°C +176°F

**Colors:**  
 Black - Orange - Ferrari red - Electric blue

## TECHNICAL DRAWING

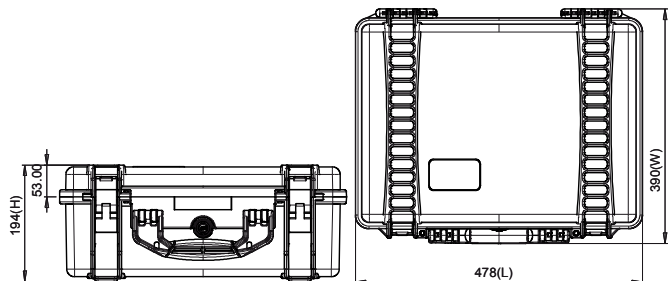

			   
* cubed foam	* interior bag	* soft padded open deck + dividers	<b>APPROVALS</b> ATA 300 IP67 STANAG 4280 DS 81-41
			<b>TEST</b> DROP IMPACT HANDLE WATERTIGHT INTEGRITY UV COLOR AND MATERIAL PROTECTION
			

## ACCESSORIES

<b>HPRCCUB2500</b> CUBED FOAM USA:HPRCFO (foam only)	<b>HPRCLO708TSA-1</b> PADLOCK - TSA	<b>HPRCBAG2500</b> INTERIOR BAG USA:HPRCIC (internal case)	<b>HPRCORG2500</b> LID ORGANIZER	<b>HPRCPF-006-01</b> PANEL FRAME (panel not included)	<b>HPRCSFD2500</b> SOFT PADDED OPEN DECK + DIVIDERS USA: HPRCDK (divider kit)
					

\* open cases images reflect the different HPRC cases internal options



\* open cases images reflect the different HPRC cases internal options



## TECHNICAL FEATURES

### Dimension:

internal dimension 513x288x132(mm) - 20.20x11.34x5.20(in)  
external dimension 540x350x153(mm) - 21.26x13.78x6.02(in)



lid: 46(mm) - 1.81(in) bottom: 86(mm) - 3.25(in)

### Weight:

empty: 3,20kg - 7.05lbs  
with cubed foam: 3,26kg - 7.19lbs

### Temperature rating:

Minimum -40°C -40°F      Maximum +80°C +176°F

### Colors:

Black

## TECHNICAL DRAWING

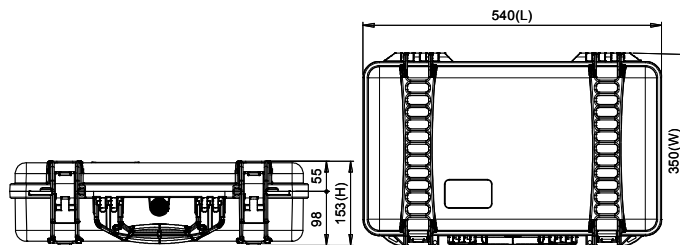

* cubed foam	* soft padded open deck + dividers	* interior bag	<b>APPROVALS</b> ATA 300 IP67 STANAG 4280 DS 81-41  <b>TEST</b> DROP IMPACT HANDLE WATERTIGHT INTEGRITY UV COLOR AND MATERIAL PROTECTION  volume in litres  included

## ACCESSORIES

<b>HPRCCUB2530</b> CUBED FOAM USA:HPRCFO (foam only)	<b>HPRCLO708TSA-1</b> PADLOCK - TSA	<b>HPRCSTRAP</b>	<b>HPRCORG2530</b> LID ORGANIZER	<b>HPRCSFD2530</b> SOFT PADDED OPEN DECK + DIVIDERS USA: HPRCDK (divider kit)	<b>HPRCBAG2530</b> INTERIOR BAG USA:HPRCIC (internal case)

# HPRC 2550W

NEW  
V.2017



\* open cases images reflect the different HPRC cases internal options

## TECHNICAL FEATURES

### Dimension:

internal dimension 513x288x200(mm) - 20.19x11.34x7.87(in)  
external dimension 549x346x236(mm) - 21.61x13.62x9.29(in)

lid: 48(mm) - 1.88(in) bottom: 152(mm) - 5.98(in)

### Weight:

empty: 4.35kg - 9.57lbs

### Temperature rating:

Minimum -40°C -40°F Maximum +80°C +176°F

### Colors:

Black - Orange - Ferrari red - Electric blue



## TECHNICAL DRAWING

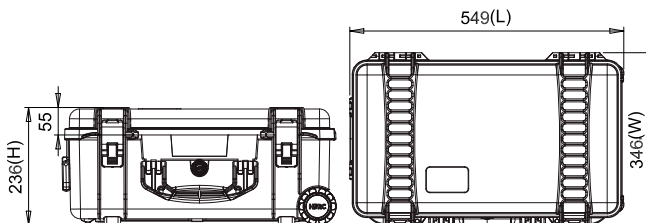

\* cubed foam



\* interior bag



\* second skin



**APPROVALS**  
ATA 300  
IP67  
STANAG 4280  
DS 81-41

**TEST**  
DROP  
IMPACT  
HANDLE  
WATERTIGHT INTEGRITY  
UV COLOR AND MATERIAL  
PROTECTION



## ACCESSORIES

**HPRCCUB2550W**  
CUBED FOAM  
USA:HPRCFO (foam only)



**HPRCLO708TSA-1**  
PADLOCK - TSA



**HPRCBAG2550W-01**  
INTERIOR BAG  
USA:HPRCIC (internal case)



**HPRCORG-004-01**  
LID ORGANIZER



**HPRCSSK2550W-01**  
SECOND SKIN



\* open cases images reflect the different HPRC cases internal options



## TECHNICAL FEATURES

### Dimension:

internal dimension 390x310x89(mm) - 15.35x12.20x3.50(in)  
external dimension 410x359x110(mm) - 16.14x14.13x4.33(in)



lid: 44(mm) - 1.73(in) bottom: 45(mm) - 1.77(in)

### Weight:

empty: 2,40kg - 5.29lbs  
with cubed foam: 2,57kg - 5.67lbs



### Temperature rating:

Minimum -40°C -40°F      Maximum +80°C +176°F



**Colors:**  
Black

## TECHNICAL DRAWING

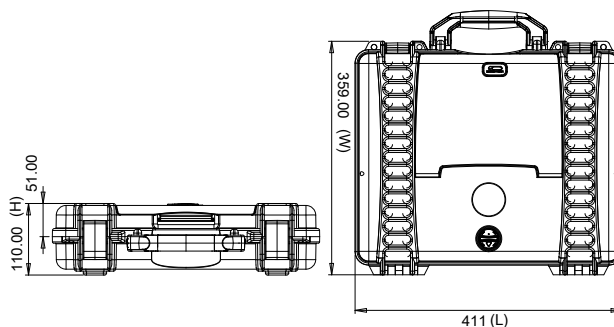

<p>* cubed foam</p>	<p>* interior bag</p>		
<p><b>APPROVALS</b> ATA 300 IP67 STANAG 4280 DS 81-41</p>			<p><b>TEST</b> DROP IMPACT HANDLE WATERTIGHT INTEGRITY UV COLOR AND MATERIAL PROTECTION</p>

## ACCESSORIES

<p><b>HPRCCUB2580</b> CUBED FOAM USA:HPRCFO (foam only)</p>	<p><b>HPRCLO708TSA-1</b> PADLOCK - TSA</p>	<p><b>HPRCSTRAP</b></p>	<p><b>HPRCORG2580</b> LID ORGANIZER</p>
---	--	-------------------------	---

# HPRC 2600



\* open cases images reflect the different HPRC cases internal options

## TECHNICAL FEATURES

**Dimension:**  
 internal dimension 482x358x198(mm) - 18.97x14.09x7.79(in)  
 external dimension 543x419x218(mm) - 21.37x16.49x8.58(in)

**lt34**

lid: 46(mm) - 1.81(in) bottom: 152(mm) - 5.98(in)

**Weight:**  
 empty: 4,25kg - 9.37lbs  
 with cubed foam: 5,05kg - 11.13lbs

**Temperature rating:**  
 Minimum -40°C -40°F  
 Maximum +80°C +176°F

**Colors:**  
 Black - Orange - Ferrari red - Electric blue

## TECHNICAL DRAWING

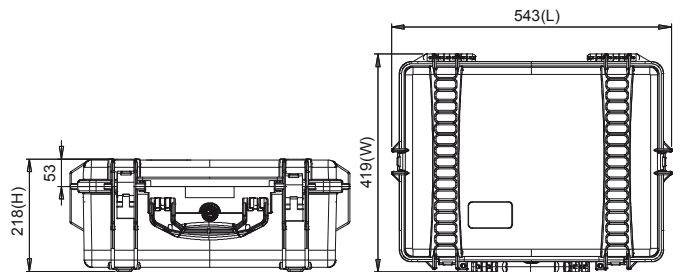

<p>* cubed foam</p>	<p>* interior bag</p>	<p>* second skin</p>	<p><b>APPROVALS</b>          ATA 300          IP67          STANAG 4280          DS 81-41</p> <p><b>TEST</b>          DROP          IMPACT          HANDLE          WATERTIGHT INTEGRITY          UV COLOR AND MATERIAL          PROTECTION</p> <p>lt volume in litres  </p>

## ACCESSORIES

<p><b>HPRCCUB2600</b>          CUBED FOAM          USA:HPRCFO (foam only)</p>	<p><b>HPRCLO708TSA-1</b>          PADLOCK - TSA</p>	<p><b>HPRCBAG2600</b>          INTERIOR BAG          USA:HPRCIC (internal case)</p>	<p><b>HPRCORG2600</b>          LID ORGANIZER</p>	<p><b>HPRPCF-007-01</b>          PANEL FRAME          (panel not included)</p>	<p><b>HPRCSSK2600-01</b>          SECOND SKIN</p>
---	---	---	--	--	---

# HPRC 2600W

\* open cases images reflect the different HPRC cases internal options



## TECHNICAL FEATURES

### Dimension:

internal dimension 482x358x218(mm) - 18.98x14.09x8.58(in)  
external dimension 546x423x250(mm) - 21.05x16.65x9.84(in)

lid: 46(mm) - 1.81(in) bottom: 172(mm) - 6.77(in)

### Weight:

empty: 6,05kg - 13.34lbs  
with cubed foam: 6,97kg - 15.37lbs

### Temperature rating:

Minimum -40°C -40°F Maximum +80°C +176°F

### Colors:

Black - Orange - Electric blue

lt38

W

## TECHNICAL DRAWING

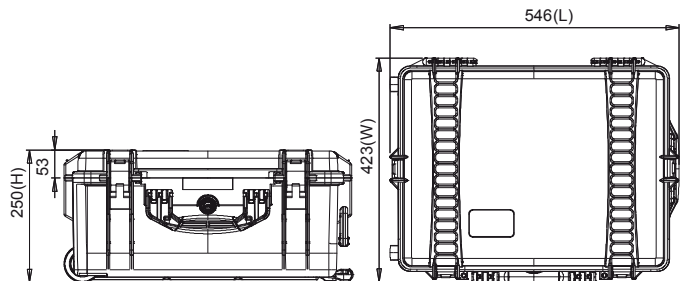

\* cubed foam

\* interior bag

\* second skin



**APPROVALS**  
ATA 300  
IP67  
STANAG 4280  
DS 81-41

**TEST**  
DROP  
IMPACT  
HANDLE  
WATERTIGHT INTEGRITY  
UV COLOR AND MATERIAL  
PROTECTION

lit volume in litres  
W

## ACCESSORIES

**HPRCCUB2600W**  
CUBED FOAM  
USA:HPRCFO (foam only)

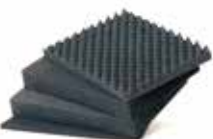

**HPRCLO708TSA-1**  
PADLOCK - TSA



**HPRCBAG600W**  
INTERIOR BAG  
USA:HPRCIC (internal case)



**HPRCORG2600W**  
LID ORGANIZER



**HPRCPF-008-01**  
PANEL FRAME  
(panel not included)



**HPRCSSK2600W-01**  
SECOND SKIN



SECOND SKIN



# HPRC 2700



\* open cases images reflect the different HPRC cases internal options

## TECHNICAL FEATURES

### Dimension:

internal dimension 555x459x205(mm) - 21.85x18.07x8.07(in)  
external dimension 617x525x227(mm) - 24.29x20.67x8.94(in)



lid: 45(mm) - 1.77(in) bottom: 160(mm) - 6.29(in)

### Weight:

empty: 5,55kg - 12.24lbs  
with cubed foam: 6,71kg - 14.79lbs

### Temperature rating:

Minimum Maximum  
-40°C -40°F +80°C +176°F

### Colors:

Black - Orange - Ferrari red

## TECHNICAL DRAWING

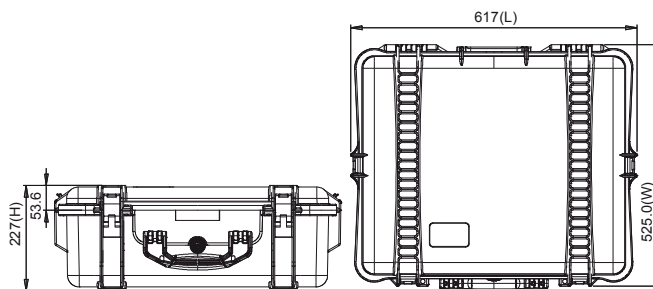

* cubed foam	* interior bag	* soft padded open deck + dividers	<b>APPROVALS</b> ATA 300 IP67 STANAG 4280 DS 81-41
			<b>TEST</b> DROP IMPACT HANDLE WATERTIGHT INTEGRITY UV COLOR AND MATERIAL PROTECTION
			 volume in litres wheeled

## ACCESSORIES

<b>HPRCCUB2700</b> CUBED FOAM USA:HPRCFO (foam only)	<b>HPRCLO708TSA-1</b> PADLOCK - TSA	<b>HPRCBAG2700</b> INTERIOR BAG USA:HPRCIC (internal case)	<b>HPRCORG2700</b> LID ORGANIZER	<b>HPRCSFD2700</b> SOFT PADDED OPEN DECK + DIVIDERS USA: HPRCDK (divider kit)

\* open cases images reflect the different HPRC cases internal options

# HPRC 2700W



## TECHNICAL FEATURES

**Dimension:**  
 internal dimension 555x459x256(mm) - 21.85x18.07x10.08(in)  
 external dimension 620x525x280(mm) - 24.41x20.67x11.02(in)

lt65

lid: 45(mm) - 1.77(in) bottom: 211(mm) - 8.30(in)

W

**Weight:**  
 empty: 8,30kg - 18.30lbs  
 with cubed foam: 9,07kg - 19.99lbs

**Temperature rating:**  
 Minimum -40°C -40°F Maximum +80°C +176°F

**Colors:**  
 Black - Orange - Ferrari red

## TECHNICAL DRAWING

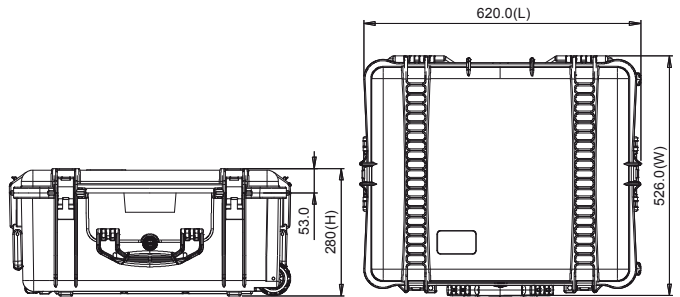

\* cubed foam



\* interior bag

NEW



\* second skin



**APPROVALS**  
 ATA 300  
 IP67  
 STANAG 4280  
 DS 81-41

**TEST**  
 DROP  
 IMPACT  
 HANDLE  
 WATERTIGHT INTEGRITY  
 UV COLOR AND MATERIAL  
 PROTECTION

lt volume in litres  
 W

## ACCESSORIES

**HPRCCUB2700W**  
 CUBED FOAM  
 USA:HPRCFO (foam only)

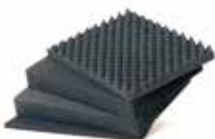

**HPRCL0708TSA-1**  
 PADLOCK - TSA



**HPRCBAG2700W**  
 INTERIOR BAG  
 USA:HPRCIC (internal case)



**HPRCORG2700W**  
 LID ORGANIZER



**HPRCSSK2700W-01**  
 SECOND SKIN



# HPRC 2710



\* open cases images reflect the different HPRC cases internal options

## TECHNICAL FEATURES

### Dimension:

internal dimension 555x459x256(mm) - 21.85x18.07x10.08(in)  
external dimension 617x525x280(mm) - 24.29x20.67x11.02(in)



lid: 45(mm) - 1.77(in) bottom: 211(mm) - 8.30(in)

### Weight:

empty: 6.71kg - 14.76lbs

### Temperature rating:

Minimum -40°C -40°F      Maximum +80°C +176°F

### Colors:

Black

## TECHNICAL DRAWING

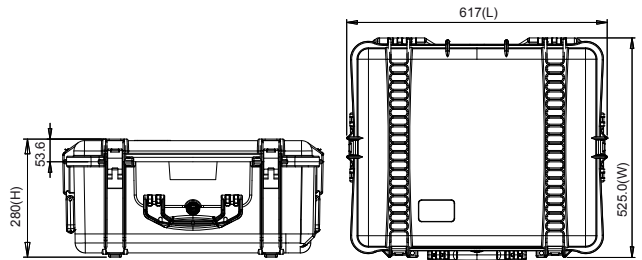

\* cubed foam



**APPROVALS**  
ATA 300  
IP67  
STANAG 4280  
DS 81-41

**TEST**  
DROP  
IMPACT  
HANDLE  
WATERTIGHT INTEGRITY  
UV COLOR AND MATERIAL  
PROTECTION



## ACCESSORIES

**HPRCCUB2710**  
CUBED FOAM  
USA:HPRCFO (foam only)



**HPRCLO708TSA-1**  
PADLOCK - TSA



• open cases images reflect the different HPRC cases internal options

# HPRC 2730W



## TECHNICAL FEATURES

### Dimension:

internal dimension 509x460x316(mm) - 20.04x18.11x12.44(in)  
external dimension 620x520x350(mm) - 24.41x20.47x13.78(in)



lid: 45(mm) - 1.77(in) bottom: 271(mm) - 10.66(in)

### Weight:

empty: 7,55kg - 16.64lbs  
with cubed foam: 10,43kg - 22.99lbs

### Temperature rating:

Minimum -40°C -40°F Maximum +80°C +176°F

### Colors:

Black

## TECHNICAL DRAWING

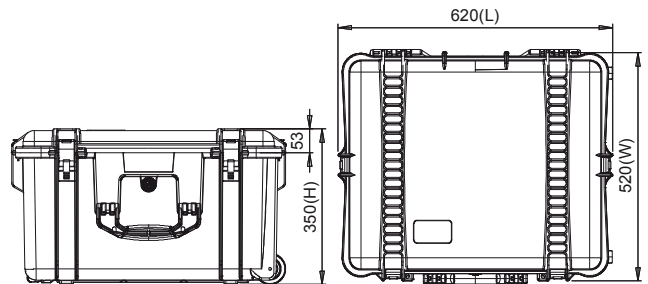

<p>* cubed foam</p>	<p>* interior bag</p>	<p>* soft padded open deck + dividers</p>	<p><b>APPROVALS</b> ATA 300 IP67 STANAG 4280 DS 81-41</p> <p><b>TEST</b> DROP IMPACT HANDLE WATERTIGHT INTEGRITY UV COLOR AND MATERIAL PROTECTION</p> <p>lit volume in litres wheeled</p>
---------------------	-----------------------	---	---

## ACCESSORIES

<p><b>HPRCCUB2730W</b> CUBED FOAM USA:HPRCFO (foam only)</p>	<p><b>HPRCLO708TSA-1</b> PADLOCK - TSA</p>	<p><b>HPRCBAG2730W</b> INTERIOR BAG USA:HPRCIC (internal case)</p>	<p><b>HPRCORG2730W</b> LID ORGANIZER</p>	<p><b>HPRCSFD2730W</b> SOFT PADDED OPEN DECK + DIVIDERS USA: HPRCDK (divider kit)</p>
--	--	--	--	---

# HPRC 2760W



## When innovation becomes a case

Main features:

- 4 built in wheels: roll the case along by simply pushing it while it's on the ground
- two side handles: push or pull the case as a trolley
- stackable exterior lid design: use the case as a cart by stacking more cases on top of each other
- two lateral handles: when you need to hold the case from both sides
- comfortable soft-grip handle
- braked wheels to prevent unexpected movement





# HPRC 2760W

• open cases images reflect the different HPRC cases internal options



## TECHNICAL FEATURES

### Dimension:

internal dimension 690x450x300(mm) - 27.16x17.71x11.81(in)  
external dimension 750x510x329(mm) - 29.53x20.08x12.99(in)

lt91

lid: 50(mm) - 1.97(in) bottom: 250(mm) - 9.84(in)

W

### Weight:

empty: 9,20kg - 20.28lbs  
with cubed foam: 10,72kg - 23.63lbs

### Temperature rating:

Minimum Maximum  
-40°C -40°F +80°C +176°F

### Colors:

Black

## TECHNICAL DRAWING

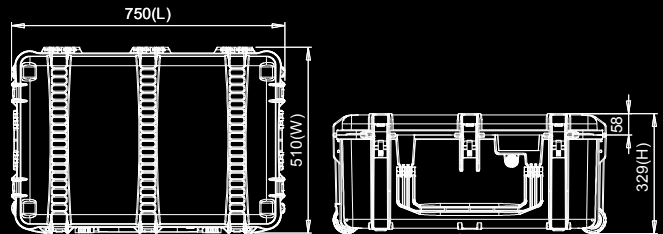

\* cubed foam



\* interior bag



\* soft padded open deck + dividers



**APPROVALS**  
ATA 300  
IP67  
STANAG 4280  
DS 81-41

**TEST**  
DROP  
IMPACT  
HANDLE  
WATERTIGHT INTEGRITY  
UV COLOR AND MATERIAL  
PROTECTION

It's volume in litres

W

## ACCESSORIES

**HPRCCUB2760W**  
CUBED FOAM  
USA:HPRCFO (foam only)

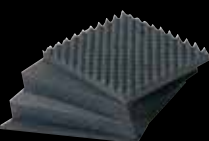

**HPRCLO708TSA-1**  
PADLOCK - TSA



**HPRCBAG2760W**  
Interior bag  
USA:HPRCIC (internal case)



**HPRCSFD2760W** SOFT PADDED  
OPEN DECK + DIVIDERS USA:  
HPRCDK (divider kit)



# HPRC 2780W



## TECHNICAL FEATURES

**Dimension:**  
 internal dimension 749x525x366(mm) - 29.49x20.67x14.41(in)  
 external dimension 810x586,5x388(mm) - 31.89x23.09x15.28(in)

lid: 73(mm) - 2.87(in) bottom: 293(mm) - 11.53(in)

**Weight:**  
 empty: 12,20kg - 26.90lbs  
 with cubed foam: 16,18kg - 35.67lbs

**Temperature rating:**  
 Minimum -40°C -40°F Maximum +80°C +176°F

**Colors:**  
 Black



## TECHNICAL DRAWING

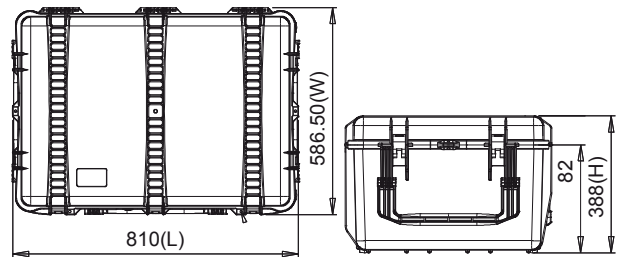

* cubed foam	* interior bag	* soft padded open deck + dividers	<p><b>APPROVALS</b>                  ATA 300                  IP67                  STANAG 4280                  DS 81-41</p> <p><b>TEST</b>                  DROP                  IMPACT                  HANDLE                  WATERTIGHT INTEGRITY                  UV COLOR AND MATERIAL                  PROTECTION</p>



## ACCESSORIES

<p><b>HPRCCUB2780W</b>                  CUBED FOAM                  USA:HPRCFO (foam only)</p>	<p><b>HPRCLO708TSA-1</b>                  PADLOCK - TSA</p>	<p><b>HPRCBAG2780W</b>                  INTERIOR BAG                  USA:HPRCIC (internal case)</p>	<p><b>HPRCORG2780W</b>                  LID ORGANIZER</p>	<p><b>HPRCSFD2780W</b> SOFT PADDED                  OPEN DECK + DIVIDERS USA:                  HPRCDK (divider kit)</p>
--	---	--	---	---

\* open cases images reflect the different HPRC cases internal options

# HPRC 2800W

\* open cases images reflect the different HPRC cases internal options



## TECHNICAL FEATURES

### Dimension:

internal dimension 749x525x455(mm) - 29.49x20.67x17.91(in)  
external dimension 810x586,5x479(mm) - 31.89x23.09x18.86(in)

lid: 73(mm) - 2.87(in) bottom: 382(mm) - 15.03(in)

### Weight:

empty: 13,20kg - 29.10lbs  
with cubed foam: 17,43kg - 38.43lbs

### Temperature rating:

Minimum -40°C -40°F Maximum +80°C +176°F

### Colors:

Black



## TECHNICAL DRAWING

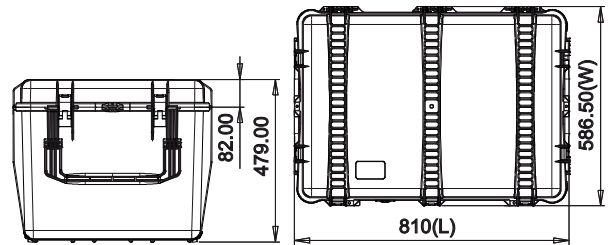

\* cubed foam



\* interior bag



\* soft padded open deck + dividers



**APPROVALS**  
ATA 300  
IP67  
STANAG 4280  
DS 81-41

**TEST**  
DROP  
IMPACT  
HANDLE  
WATERTIGHT INTEGRITY  
UV COLOR AND MATERIAL  
PROTECTION



## ACCESSORIES

**HPRCCUB2800W**  
CUBED FOAM  
USA:HPRCFO (foam only)



**HPRCLO708TSA-1**  
PADLOCK - TSA



**HPRCBAG2800W**  
INTERIOR BAG  
USA:HPRCIC (internal case)



**HPRCORG2800W**  
LID ORGANIZER



**HPRCSFD800W** SOFT PADDED  
OPEN DECK + DIVIDERS USA:  
HPRCDK (divider kit)



# HPRC 3500



## TECHNICAL FEATURES

### Dimension:

internal dimension 433x319x169(mm) - 17.05x12.56x6.65(in)  
external dimension 498x370x185(mm) - 19.61x14.57x7.28(in)



lid: 72(mm) - 2.83(in) bottom: 97(mm) - 3.81(in)

### Weight:

empty: 3,00kg - 6.61lbs  
with cubed foam: 3,55kg - 7.82lbs



### Temperature rating:

Minimum Maximum  
-40°C -40°F +80°C +176°F

### Colors:

Black

## TECHNICAL DRAWING

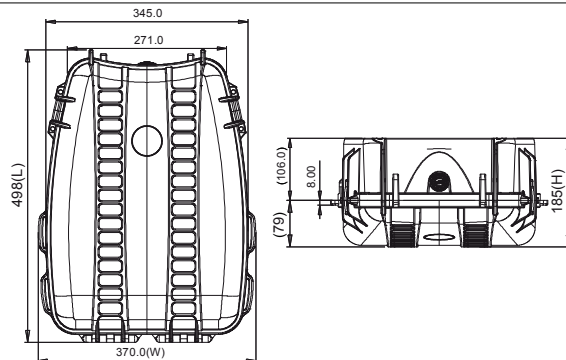

\* cubed foam



\* interior bag



**APPROVALS**  
ATA 300  
IP67  
STANAG 4280  
DS 81-41

**TEST**  
DROP  
IMPACT  
HANDLE  
WATERTIGHT INTEGRITY  
UV COLOR AND MATERIAL  
PROTECTION



## ACCESSORIES

**HPRCCUB3500**  
CUBED FOAM  
USA:HPRCFO (foam only)

**HPRCBAG3500**  
INTERIOR BAG  
USA:HPRCIC (internal case)

**HPRCORG3500**  
LID ORGANIZER







# HPRC 4050



\* open cases images reflect the different HPRC cases internal options

## TECHNICAL FEATURES

**Dimension:**  
 internal dimension 261x171x220(mm) - 10.28x6.73x8.66(in)  
 external dimension 284x223x260(mm) - 11.18x8.78x10.24(in)



lid: 24(mm) - 0.94(in) bottom: 196(mm) - 7.71(in)



**Weight:**  
 empty: 1,66kg - 3.66lbs  
 with cubed foam: 1,85kg - 4.07lbs

**Temperature rating:**  
 Minimum -40°C -40°F      Maximum +80°C +176°F

**Colors:**  
 Black

## TECHNICAL DRAWING

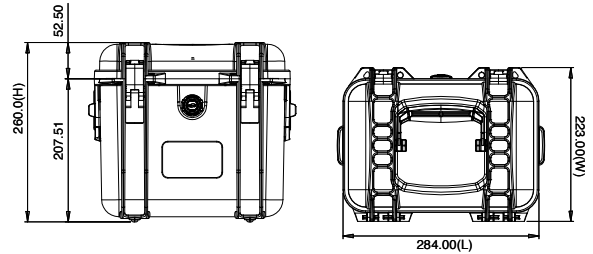

			<p><b>APPROVALS</b>          ATA 300          IP67          STANAG 4280          DS 81-41</p> <p><b>TEST</b>          DROP          IMPACT          HANDLE          WATERTIGHT INTEGRITY          UV COLOR AND MATERIAL          PROTECTION</p> <p>tested in Europe  </p>
--	--	--	---

## ACCESSORIES

<p><b>HPRCCUB4050</b>          CUBED FOAM          USA:HPRCFO (foam only)</p>	<p><b>HPRCLO708TSA-1</b>          PADLOCK - TSA</p>	<p><b>HPRCPADDEDSTRAP</b></p>	<p><b>HPRCSFD4050</b> SOFT PADDED          OPEN DECK + DIVIDERS USA:          HPRCDK (divider kit)</p>	<p><b>HPRCPANELFRAME</b>          SUPPORT KIT</p>	
---	---	-------------------------------	--	---	--

**SHOULDER  
CASE**



## TECHNICAL FEATURES

### Dimension:

internal dimension 401x231x231(mm) - 15.79x9.09x9.09(in)  
external dimension 424x284x276,5(mm) - 16.69x11.18x10.89(in)

lid: 46(mm) - 1.81(in) bottom: 185(mm) - 7.28(in)

### Weight:

empty: 2,78kg - 6.13lbs  
with cubed foam: 3,27kg - 7.20lbs

### Temperature rating:

Minimum -40°C -40°F      Maximum +80°C +176°F

### Colors:

Black



## TECHNICAL DRAWING

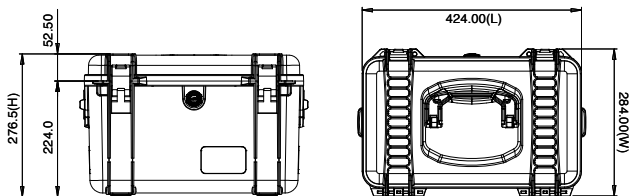

<p>* cubed foam</p>	<p>* soft padded open deck + dividers</p>	<p><b>APPROVALS</b> ATA 300 IP67 STANAG 4280 DS 81-41</p> <p><b>TEST</b> DROP IMPACT HANDLE WATERTIGHT INTEGRITY UV COLOR AND MATERIAL PROTECTION</p> <p>volume in litres </p>

## ACCESSORIES

<p><b>HPRCCUB4100</b> CUBED FOAM USA:HPRCFO (foam only)</p>	<p><b>HPRCL0708TSA-1</b> PADLOCK - TSA</p>	<p><b>HPRCPADDEDSTRAP</b></p>	<p><b>HPRCSFD4100</b> SOFT PADDED OPEN DECK + DIVIDERS USA: HPRCDK (divider kit)</p>	<p><b>HPRCPANELFRAME</b> SUPPORT KIT</p>	
---	--	-------------------------------	--	--	--



# HPRC 4200

**SHOULDER  
CASE**



## TECHNICAL FEATURES

**Dimension:**  
internal dimension 460x240x400(mm) - 18.11x9.45x15.75(in)  
external dimension 483x293x445,5(mm) - 19.02x11.54x17.54(in)

**lt44**

lid: 66(mm) - 2.60(in) bottom: 334(mm) - 13.14(in)

**Weight:**  
empty: 5,00kg - 11.02lbs  
with cubed foam: 6,03kg - 13.29lbs

**Temperature rating:**  
Minimum -40°C -40°F  
Maximum +80°C +176°F

**Colors:**  
Black

## TECHNICAL DRAWING

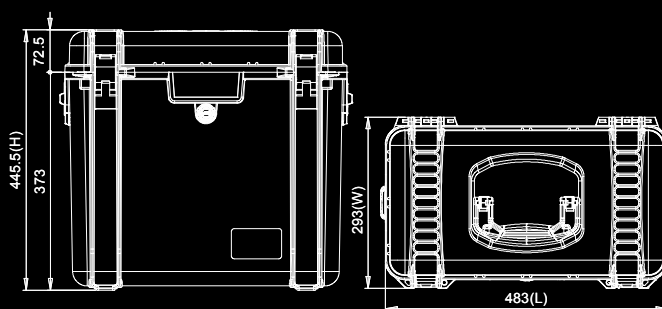

**APPROVALS**  
ATA 300  
IP67  
STANAG 4280  
DS 81-41

**TEST**  
DROP  
IMPACT  
HANDLE  
WATERTIGHT INTEGRITY  
UV COLOR AND MATERIAL  
PROTECTION



## ACCESSORIES

**HPRCCUB4200**  
CUBED FOAM  
USA:HPRCFO (foam only)

**HPRCLO708TSA-1**  
PADLOCK - TSA

**HPRCCBAG4200**  
INTERIOR BAG  
USA:HPRCIC (internal case)

**HPRCPADDEDSTRAP**

**HPRCSFD4200** SOFT PADDED  
OPEN DECK + DIVIDERS USA:  
HPRCDK (divider kit)

**HPRCPANELFRAME**  
SUPPORT KIT



\* open cases images reflect the different HPRC cases internal options



## TECHNICAL FEATURES

### Dimension:

internal dimension 585x320x309(mm) - 23.03x12.60x12.17(in)  
external dimension 690x380x355(mm) - 27.17x14.96x13.98(in)



lid: 80(mm) - 3.15(in) bottom: 229(mm) - 9.01(in)

### Weight:

empty: 6,50kg - 14.33lbs  
with cubed foam: 7,96kg - 17.54lbs

### Temperature rating:

Minimum -40°C -40°F      Maximum +80°C +176°F

### Colors:

Black

## TECHNICAL DRAWING

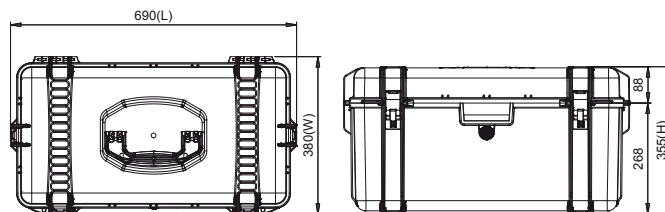

<p>* cubed foam</p>	<p>* interior bag</p>	<p>* soft padded open deck + dividers</p>	<p><b>APPROVALS</b> ATA 300 IP67 STANAG 4280 DS 81-41</p> <p><b>TEST</b> DROP IMPACT HANDLE WATERTIGHT INTEGRITY UV COLOR AND MATERIAL PROTECTION</p> <p>lt volume in litres </p>

## ACCESSORIES

<p><b>HPRCCUB4300</b> CUBED FOAM USA:HPRCFO (foam only)</p>	<p><b>HPRCLO708TSA-1</b> PADLOCK - TSA</p>	<p><b>HPRCBAG4300</b> INTERIOR BAG USA:HPRCIC (internal case)</p>	<p><b>HPRCSFD4300</b> SOFT PADDED OPEN DECK + DIVIDERS USA: HPRCDK (divider kit)</p>
---	--	---	--



# HPRC 4300W



## TECHNICAL FEATURES

### Dimension:

internal dimension 585x320x300(mm) - 23.03x12.60x11.81(in)  
external dimension 690x380x358(mm) - 27.17x14.96x14.09(in)

**lt62**

**W**

lid: 80(mm) - 3.15(in) bottom: 220(mm) - 8.66(in)

### Weight:

empty: 7,30kg - 16.09lbs  
with cubed foam: 8,76kg - 19.31lbs

### Temperature rating:

Minimum -40°C -40°F Maximum +80°C +176°F

### Colors:

Black

## TECHNICAL DRAWING

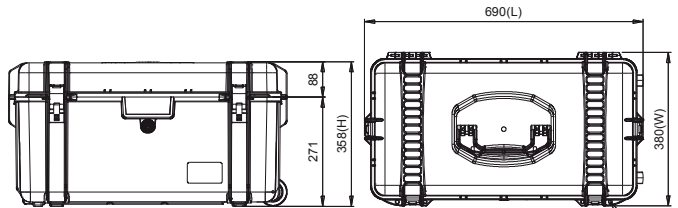

**APPROVALS**  
ATA 300  
IP67  
STANAG 4280  
DS 81-41

**TEST**  
DROP  
IMPACT  
HANDLE  
WATERTIGHT INTEGRITY  
UV COLOR AND MATERIAL  
PROTECTION

**lt** volume in litres  
**W** wheeled

\* cubed foam

\* interior bag

\* soft padded open deck + dividers

## ACCESSORIES

**HPRCCUB4300W**  
CUBED FOAM  
USA:HPRCFO (foam only)

**HPRCLO708TSA-1**  
PADLOCK - TSA

**HPRCBAG4300W**  
INTERIOR BAG  
USA:HPRCIC (internal case)

**HPRCSFD4300W** SOFT PADDED  
OPEN DECK + DIVIDERS USA:  
HPRCDK (divider kit)



# HPRC 4400

\* open cases images reflect the different HPRC cases internal options



## TECHNICAL FEATURES

### Dimension:

internal dimension 420x420x389(mm) - 16.54x16.54x15.31(in)  
external dimension 479x481x437(mm) - 18.86x18.94x17.20(in)

**lt 74**

lid: 65(mm) - 2.56(in) bottom: 324(mm) - 12.75(in)

### Weight:

empty: 6,70kg - 14.77lbs  
with cubed foam: 8,90kg - 19.62lbs

### Temperature rating:

Minimum -40°C -40°F      Maximum +80°C +176°F

### Colors:

Black

## TECHNICAL DRAWING

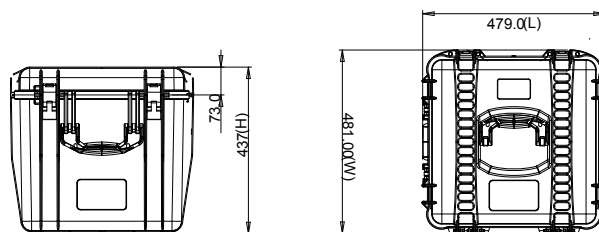

\* cubed foam



### APPROVALS

ATA 300  
IP67  
STANAG 4280  
DS 81-41

### TEST

DROP  
IMPACT  
HANDLE  
WATERTIGHT INTEGRITY  
UV COLOR AND MATERIAL  
PROTECTION

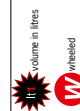

## ACCESSORIES

### HPRCCUB4400

CUBED FOAM  
USA:HPRCFO (foam only)



### HPRCLO708TSA-1

PADLOCK - TSA



### HPRCKITW4400

wheel kit for 4400



# HPRC 4600W



\* open cases images reflect the different HPRC cases internal options

## TECHNICAL FEATURES

### Dimension:

internal dimension 611x611x345(mm) - 24.05x24.05x13.58(in)  
external dimension 670x677x388.5(mm) - 26.38x26.65x15.3(in)



lid: 55.5(mm) - 2.18(in) bottom: 289(mm) - 11.37(in)

### Weight:

empty: 9,9kg - 21.83lbs



### Temperature rating:

Minimum -40°C -40°F Maximum +80°C +176°F

### Colors:

Black

## TECHNICAL DRAWING

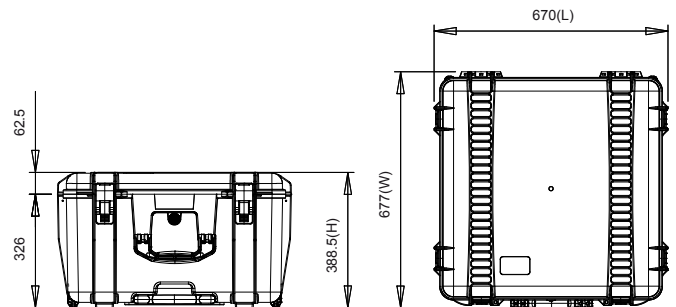

\* cubed foam



### APPROVALS

ATA 300  
IP67  
STANAG 4280  
DS 81-41

### TEST

DROP  
IMPACT  
HANDLE  
WATERTIGHT INTEGRITY  
UV COLOR AND MATERIAL  
PROTECTION



## ACCESSORIES

**HPRCCUB4600W**  
CUBED FOAM  
USA:HPRCFO (foam only)



**HPRCLO708TSA-1**  
PADLOCK - TSA







# HPRC 4700W



## TECHNICAL FEATURES

### Dimension:

internal dimension 508x301x497(mm) - 20.00x11.85x19.57(in)  
external dimension 572x412x564(mm) - 22.52x16.22x22.20(in)

**lt81**



lid: 23(mm) - 0.91(in) bottom: 474(mm) - 18.66(in)

### Weight:

empty: 11,60kg - 25.57lbs  
with cubed foam: 14,84kg - 32.71lbs

### Temperature rating:

Minimum -40°C -40°F      Maximum +80°C +176°F

### Colors:

Black

## TECHNICAL DRAWING

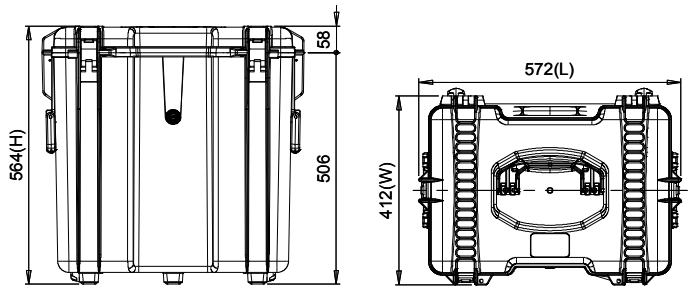

\* cubed foam



\* interior bag



**APPROVALS**  
ATA 300  
IP67  
STANAG 4280  
DS 81-41

**TEST**  
DROP  
IMPACT  
HANDLE  
WATERTIGHT INTEGRITY  
UV COLOR AND MATERIAL  
PROTECTION

lt volume in litres  
w wheeled

## ACCESSORIES

**HPRCCUB4700W**  
CUBED FOAM  
USA:HPRCFO (foam only)



**HPRCLO708TSA-1**  
PADLOCK - TSA



**HPRCBAG4700W**  
Interior bag  
USA:HPRCIC (internal case)





# HPRC 4800W



\* open cases images reflect the different HPRC cases internal options

## TECHNICAL FEATURES

### Dimension:

internal dimension 720x320x600(mm) - 28.34x12.60x23.62(in)  
external dimension 776x380x649(mm) - 30.55x14.96x25.55(in)

lid: 60(mm) - 2.36(in) bottom: 540(mm) - 21.25(in)

### Weight:

empty: 10,00kg - 22.21lbs  
with cubed foam: 14,10kg - 31.08lbs

### Temperature rating:

Minimum -40°C -40°F      Maximum +80°C +176°F

### Colors:

Black



## TECHNICAL DRAWING

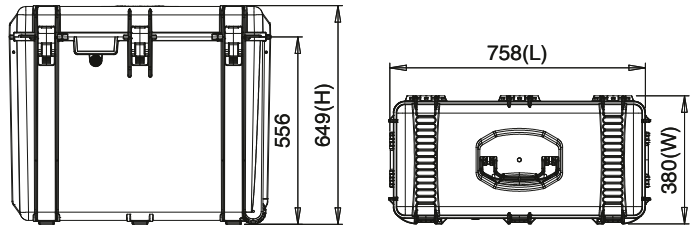

\* cubed foam



\* interior bag



**APPROVALS**  
ATA 300  
IP67  
STANAG 4280  
DS 81-41

**TEST**  
DROP  
IMPACT  
HANDLE  
WATERTIGHT INTEGRITY  
UV COLOR AND MATERIAL  
PROTECTION



## ACCESSORIES

**HPRCCUB4800W**  
CUBED FOAM  
USA:HPRCFO (foam only)



**HPRCLO708TSA-1**  
PADLOCK - TSA



**HPRCBAG4800W**  
Interior bag  
USA:HPRCIC (internal case)



Photo by Phil Arntz





\* open cases images reflect the different HPRC cases internal options

# HPRC 5400W



## TECHNICAL FEATURES

### Dimension:

internal dimension 1140x350x160(mm) - 44.88x13.78x6.30(in)  
external dimension 1175x410x181(mm) - 46.26x16.14x7.13(in)

lid: 45(mm) - 1.77(in) bottom: 115(mm) - 4.52(in)

### Weight:

empty: 7,90kg - 17.42lbs  
with cubed foam: 8,80kg - 19.40lbs

### Temperature rating:

Minimum Maximum  
-40°C -40°F +80°C +176°F

### Colors:

Black



## TECHNICAL DRAWING

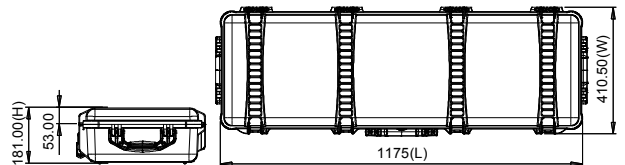

\* cubed foam

\* interior bag



**APPROVALS**  
ATA 300  
IP67  
STANAG 4280  
DS 81-41

**TEST**  
DROP  
IMPACT  
HANDLE  
WATERTIGHT INTEGRITY  
UV COLOR AND MATERIAL  
PROTECTION



## ACCESSORIES

**HPRCCUB5400W**  
CUBED FOAM  
USA:HPRCFO (foam only)



**HPRCLO708TSA-1**  
PADLOCK - TSA



**HPRCBAG5400W**  
INTERIOR BAG  
USA:HPRCIC (internal case)



# HPRC 6200



## TECHNICAL FEATURES

### Dimension:

internal dimension 651x279x243(mm) - 25.63x10.98x9.57(in)  
external dimension 700x335x292(mm) - 27.56x13.19x11.50(in)

**lt38**

lid: 112(mm) - 4.41(in) bottom: 131(mm) - 5.15(in)

### Weight:

empty: 4,00kg - 8.82lbs  
with cubed foam: 5,80kg - 12.78lbs

### Temperature rating:

Minimum Maximum  
-40°C -40°F +80°C +176°F

### Colors:

Black

## TECHNICAL DRAWING

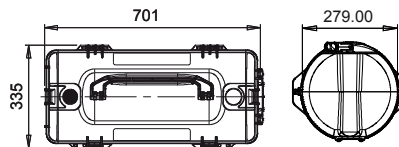

\* cubed foam



\* tri version



**APPROVALS**  
ATA 300  
IP67  
STANAG 4280  
DS 81-41

**TEST**  
DROP  
IMPACT  
HANDLE  
WATERTIGHT INTEGRITY  
UV COLOR AND MATERIAL  
PROTECTION



## ACCESSORIES

**HPRCCUB6200**  
CUBED FOAM  
USA:HPRCFO (foam only)



**HPRCTRI6200-02**  
for tripods



**HPRCLO708TSA-1**  
PADLOCK - TSA



# HPRC 6300W

\* open cases images reflect the different HPRC cases internal options



## TECHNICAL FEATURES

**Dimension:**  
 internal dimension 921x279x243(mm) - 36.26x10.98x9.57(in)  
 external dimension 970x335x285(mm) - 38.19x13.19x11.22(in)

**54**

lid: 112(mm) - 4.41(in) bottom: 131(mm) - 5.15(in)

**W**

**Weight:**  
 empty: 5,70kg - 12.57lbs  
 with cubed foam: 6,95kg - 15.32lbs

**Temperature rating:**  
 Minimum -40°C -40°F      Maximum +80°C +176°F

**Colors:**  
 Black

## TECHNICAL DRAWING

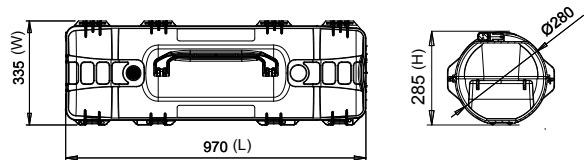

\* cubed foam



\* tri version



**APPROVALS**  
 ATA 300  
 IP67  
 STANAG 4280  
 DS 81-41

**TEST**  
 DROP  
 IMPACT  
 HANDLE  
 WATERTIGHT INTEGRITY  
 UV COLOR AND MATERIAL  
 PROTECTION

**W**  
 volume in litres  
 wheeled

## ACCESSORIES

**HPRCCUB6300W**  
 CUBED FOAM  
 USA:HPRCFO (foam only)



**HPRCTRIKIT-02**  
 for tripods



**HPRCLO708TSA-1**  
 PADLOCK - TSA





# HPRC 6400W



## TECHNICAL FEATURES

### Dimension:

internal dimension 1081x279x243(mm) - 42.56x10.98x9.57(in)  
external dimension 1128x335x258(mm) - 44.41x13.19x11.22(in)

lid: 112(mm) - 4.41(in) bottom: 131(mm) - 5.15(in)

### Weight:

empty: 6,30kg - 13.89lbs  
with cubed foam: 7,84kg - 17.28lbs

### Temperature rating:

Minimum -40°C -40°F      Maximum +80°C +176°F

### Colors:

Black



## TECHNICAL DRAWING

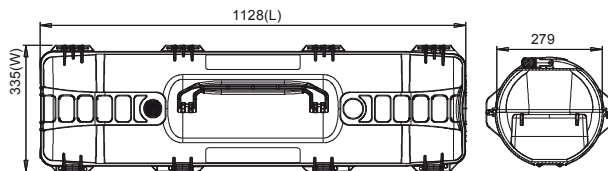

\* cubed foam



\* tri version



**APPROVALS**  
ATA 300  
IP67  
STANAG 4280  
DS 81-41

**TEST**  
DROP  
IMPACT  
HANDLE  
WATERTIGHT INTEGRITY  
UV COLOR AND MATERIAL  
PROTECTION



## ACCESSORIES

**HPRCCUB6400W**  
CUBED FOAM  
USA:HPRCFO (foam only)



**HPRCTRIKIT-02**  
for tripods



**HPRCLO708TSA-1**  
PADLOCK - TSA



# HPRC 6500W

\* open cases images reflect the different HPRC cases internal options



## TECHNICAL FEATURES

### Dimension:

internal dimension 1281x279x243(mm) - 50.43x10.98x9.57(in)  
external dimension 1330x335x285(mm) - 52.36x13.19x11.22(in)

lid: 112(mm) - 4.41(in) bottom: 131(mm) - 5.15(in)

### Weight:

empty: 7,20kg - 15.87lbs  
with cubed foam: 9,03kg - 19.90lbs

### Temperature rating:

Minimum Maximum  
-40°C -40°F +80°C +176°F

### Colors:

Black



## TECHNICAL DRAWING

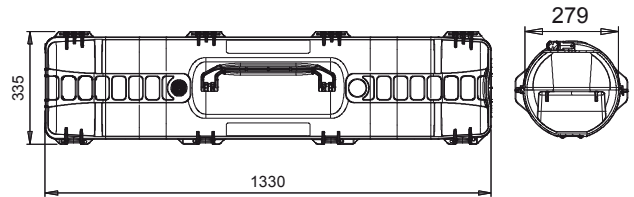

\* cubed foam



\* tri version



### APPROVALS

ATA 300  
IP67  
STANAG 4280  
DS 81-41

### TEST

DROP  
IMPACT  
HANDLE  
WATERTIGHT INTEGRITY  
UV COLOR AND MATERIAL  
PROTECTION



## ACCESSORIES

**HPRCCUB6500W**  
CUBED FOAM  
USA:HPRCFO (foam only)



**HPRCTRIKIT-02**  
for tripods



**HPRCLO708TSA-1**  
PADLOCK - TSA







## TECHNICAL FEATURES

### Dimension:

closed 394x280x27,5(mm) - 15.51x11.02x1.08(in)  
open 464x350x27,5(mm) - 18.26x13.77x1.08(in)

### Weight:

empty: 0,95kg - 2.09lbs

### Temperature rating:

Minimum Maximum  
-40°C -40°F +80°C +176°F

### Colors:

Black

## TECHNICAL DRAWING

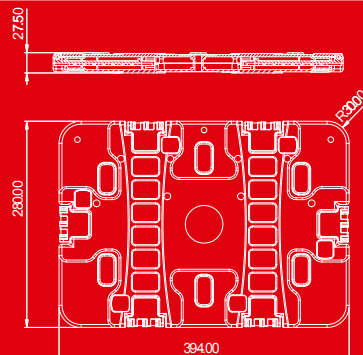

\* tripod, laptop and scheller not included



**APPROVALS**  
ATA 300  
IP67  
STANAG 4280  
DS 81-41

**TEST**  
DROP  
IMPACT  
HANDLE  
WATERTIGHT INTEGRITY  
UV COLOR AND MATERIAL  
PROTECTION



# technical chart

## HPRC1100



**internal dimension**  
57x58x25.5(mm)  
2.24x2.28x1.00(in)



**external dimension**  
69x80x32(mm)  
2.72x3.15x1.26(in)

**weight empty**  
empty: 0,04kg - 0.09lbs

**Colors**  
Black - Ferrari red

## HPRC1300



**internal dimension**  
116x67x25.5(mm)  
4.57x2.64x1.00(in)



**external dimension**  
127x90x32(mm)  
5.00x3.54x1.26(in)

**weight empty**  
empty: 0,09kg - 0.19lbs

**Colors**  
Black - Ferrari red

## HPRC2100



**internal dimension**  
210x145x94(mm)  
8.27x5.71x3.70(in)



**external dimension**  
235x196x110(mm)  
9.25x7.72x4.33(in)

**weight empty**  
empty: 0,76kg - 1.68lbs

**Colors**  
Black - Orange - Ferrari red -  
Electric blue

## HPRC2200



**internal dimension**  
236x182x108(mm)  
9.29x7.17x4.25(in)



**external dimension**  
258x230x123(mm)  
10.16x9.06x4.84(in)

**weight empty**  
empty: 0,87kg - 1.92lbs

**Colors**  
Black

## HPRC2250



**internal dimension**  
236x182x155(mm)  
9.29x7.17x6.10(in)



**external dimension**  
258x230x170(mm)  
10.16x9.06x6.69(in)

**weight empty**  
1,00kg - 2.20lbs

**Colors**  
Black

## HPRC2300



**internal dimension**  
304x231x137(mm)  
11.97x9.09x5.39(in)



**external dimension**  
335x289x155(mm)  
13.19x11.38x6.10(in)

**weight empty**  
1,67kg - 3.68lbs

**Colors**  
Black - Orange - Ferrari red -  
Electric blue

## HPRC2350



**internal dimension**  
340x235x99(mm)  
13.38x9.25x3.90(in)



**external dimension**  
365x290x115(mm)  
-14.37x11.42x4.53(in)

**weight empty**  
1.48kg - 3.25lbs



**Colors**  
Black

## HPRC2400



**internal dimension**  
380x266x152(mm)  
14.96x10.47x5.98(in)



**external dimension**  
405x330x170(mm)  
15.94x12.99x6.69(in)

**weight empty**  
2,05kg - 4.52lbs



**Colors**  
Black - Orange - Ferrari red -  
Electric blue

## HPRC2460



**internal dimension**  
409x306x175(mm)  
16.10x12.05x6.89(in)



**external dimension**  
434x371x193(mm)  
17.09x14.61x7.60(in)

**weight empty**  
2,60kg - 5.73lbs

**Colors**  
Black

## HPRC2500



**internal dimension**  
450x323x175(mm)  
17.72x12.72x6.89(in)



**external dimension**  
478x390x194(mm)  
18.82x15.35x7.64(in)

**weight empty**  
3,15kg - 6.94lbs



**Colors**  
Black - Orange - Ferrari red -  
Electric blue

## HPRC2530



**internal dimension**  
513x288x132(mm)  
20.20x11.34x5.20(in)



**external dimension**  
540x350x153(mm)  
21.26x13.78x6.02(in)

**weight empty**  
3,20kg - 7.05lbs

**Colors**  
Black

## HPRC2550W



**internal dimension**  
513x288x200(mm)  
20.19x11.34x7.87(in)



**external dimension**  
549x346x236(mm)  
21.61x13.62x9.29(in)



**weight empty**  
4,35kg - 9.57lbs





**Colors**  
Black - Orange -  
Ferrari red -  
Electric blue



**NEW**



<b>HPRC2580</b> 	
	<b>internal dimension</b> 390x310x89(mm) 15.35x12.20x3.50(in)
 <b>lt11</b>	<b>external dimension</b> 410x359x110(mm) 16.14x14.13x4.33(in)
	<b>weight empty</b> 2,40kg - 5.29lbs
	<b>Colors</b> Black



<b>HPRC2600</b> 	
	<b>internal dimension</b> 492x366x202(mm) 19.37x14.41x7.95(in)
 <b>lt34</b>	<b>external dimension</b> 555x432x223(mm) 21.85x17.01x8.78(in)
	<b>weight empty</b> 4,25kg - 9.37lbs
	<b>Colors</b> Black - Orange - Ferrari red - Electric blue





<b>HPRC2600W</b> 	
	<b>internal dimension</b> 482x358x218(mm) 18.98x14.09x8.58(in)
 <b>lt38</b>	<b>external dimension</b> 546x423x250(mm) 21.05x16.65x9.84(in)
	<b>weight empty</b> 6,05kg - 13.34lbs
	<b>Colors</b> Black - Orange - Electric blue





<b>HPRC2700</b> 	
	<b>internal dimension</b> 555x459x205(mm) 21.85x18.07x10.08(in)
 <b>lt52</b>	<b>external dimension</b> 617x525x227(mm) 24.29x20.67x8.94(in)
	<b>weight empty</b> 5,55kg - 12.24lbs
	<b>Colors</b> Black - Orange - Ferrari red





<b>HPRC2700W</b> 	
	<b>internal dimension</b> 555x459x256(mm) 21.85x18.07x10.08(in)
 <b>lt65</b>	<b>external dimension</b> 620x525x280(mm) 24.41x20.67x11.02(in)
	<b>weight empty</b> 8,30kg - 18.30lbs
	<b>Colors</b> Black - Orange - Ferrari red

<b>HPRC2710</b> 	
	<b>internal dimension</b> 555x459x256(mm) 21.85x18.07x10.08(in)
 <b>lt64</b>	<b>external dimension</b> 617x525x280(mm) 24.29x20.67x11.02(in)
	<b>weight empty</b> 6.71kg - 14.76lbs
	<b>Colors</b> Black





<b>HPRC2730W</b> 	
	<b>internal dimension</b> 509x460x316(mm) 20.04x18.11x12.44(in)
 <b>lt72</b>	<b>external dimension</b> 620x520x350(mm) 24.41x20.47x13.78(in)
	<b>weight empty</b> 7,55kg - 16.64lbs
	<b>Colors</b> Black

<b>HPRC2760W</b> 	
	<b>internal dimension</b> 690x450x300(mm) 27.16x17.71x11.81(in)
 <b>lt91</b>	<b>external dimension</b> 750x510x329(mm) 29.53x20.08x12.99(in)
	<b>weight empty</b> 9,20kg - 20.28lbs
	<b>Colors</b> Black





<b>HPRC2780W</b> 	
	<b>internal dimension</b> 749x525x366(mm) 29.49x20.67x14.41(in)
 <b>lt142</b>	<b>external dimension</b> 810x586.5x388(mm) 31.89x23.09x15.28(in)
	<b>weight empty</b> 12,20kg - 26.90lbs
	<b>Colors</b> Black

<b>HPRC2800W</b> 	
	<b>internal dimension</b> 749x525x455(mm) 29.49x20.67x17.91(in)
 <b>lt179</b>	<b>external dimension</b> 810x586.5x479(mm) 31.89x23.09x18.86(in)
	<b>weight empty</b> 13,20kg - 29.10lbs
	<b>Colors</b> Black

<b>HPRC3500</b> 	
	<b>internal dimension</b> 433x319x169(mm) 17.05x12.56x6.65(in)
 <b>lt22</b>	<b>external dimension</b> 498x370x185(mm) 19.61x14.57x7.28(in)
	<b>weight empty</b> 3,00kg - 6.61lbs
	<b>Colors</b> Black

<b>HPRC4050</b> 	
	<b>internal dimension</b> 261x171x220(mm) 10.28x6.73x8.66(in)
 <b>lt10</b>	<b>external dimension</b> 284x223x260(mm) 11.18x8.78x10.24(in)
	<b>weight empty</b> 3,00kg - 6.61lbs
	<b>Colors</b> Black

# technical chart

<p><b>HPRC4100</b> </p>  <p><b>internal dimension</b> 401x231x231(mm) 15.79x9.09x9.09(in)</p> <p><b>external dimension</b> 424x284x276,5(mm) 16.69x11.18x10.89(in)</p> <p><b>weight empty</b> 2,78kg - 6.13lbs</p> <p><b>Colors</b> Black</p> <p><b>It22</b></p> <p><b>CABIN OK</b></p>	<p><b>HPRC4200</b> </p>  <p><b>internal dimension</b> 460x240x400(mm) 18.11x9.45x15.75(in)</p> <p><b>external dimension</b> 483x293x445,5(mm) 19.02x11.54x17.54(in)</p> <p><b>weight empty</b> 5,35kg - 11.79lbs</p> <p><b>Colors</b> Black</p> <p><b>It44</b></p>	<p><b>HPRC4300</b> </p>  <p><b>internal dimension</b> 585x320x309(mm) 23.03x12.60x12.17(in)</p> <p><b>external dimension</b> 690x380x355(mm) 27.17x14.96x13.98(in)</p> <p><b>weight empty</b> 6,50kg - 14.33lbs</p> <p><b>Colors</b> Black</p> <p><b>It62</b></p>
<p><b>HPRC4300W</b> </p>  <p><b>internal dimension</b> 585x320x300(mm) 23.03x12.60x11.81(in)</p> <p><b>external dimension</b> 690x380x358(mm) 27.17x14.96x14.09(in)</p> <p><b>weight empty</b> 7,30kg - 16.09lbs</p> <p><b>Colors</b> Black</p> <p><b>It62</b></p> <p><b>W</b></p>	<p><b>HPRC4400</b> </p>  <p><b>internal dimension</b> 420x420x389(mm) 16.54x16.54x15.31(in)</p> <p><b>external dimension</b> 479x481x437(mm) 18.86x18.94x17.20(in)</p> <p><b>weight empty</b> 6,70kg - 14.77lbs</p> <p><b>Colors</b> Black</p> <p><b>It74</b></p>	<p><b>HPRC4600W</b> </p>  <p><b>internal dimension</b> 611x611x345(mm) 24.05x24.05x13.58(in)</p> <p><b>external dimension</b> 670x677x388.5(mm) 26.38x26.65x15.3(in)</p> <p><b>weight empty</b> 9,9kg - 21.83lbs</p> <p><b>Colors</b> Black</p> <p><b>It129</b></p>
<p><b>HPRC4700W</b> </p>  <p><b>internal dimension</b> 508x301x497(mm) 20.00x11.85x19.57(in)</p> <p><b>external dimension</b> 572x412x564(mm) 22.52x16.22x22.20(in)</p> <p><b>weight empty</b> 11,60kg - 25.57lbs</p> <p><b>Colors</b> Black</p> <p><b>It81</b></p> <p><b>W</b></p>	<p><b>HPRC4800W</b> </p>  <p><b>internal dimension</b> 720x320x600(mm) 28.34x12.60x23.62(in)</p> <p><b>external dimension</b> 776x380x649(mm) 30.55x14.96x25.55(in)</p> <p><b>weight empty</b> 10,00kg - 22.21lbs</p> <p><b>Colors</b> Black</p> <p><b>It136</b></p> <p><b>W</b></p>	<p><b>HPRC5400W</b> </p>  <p><b>internal dimension</b> 1140x350x160(mm) 44.88x13.78x6.30(in)</p> <p><b>external dimension</b> 1175x410x181(mm) 46.26x16.14x7.13(in)</p> <p><b>weight empty</b> 7,90kg - 17.42lbs</p> <p><b>Colors</b> Black</p> <p><b>It64</b></p> <p><b>W</b></p>

Discover all our products  
at: [www.hprc.it](http://www.hprc.it)

**HPRC6200**

**internal dimension**  
651x279x243(mm)  
25.63x10.98x9.57(in)

**external dimension**  
700x335x292(mm)  
27.56x13.19x11.50(in)

**weight empty**  
4,00kg - 8.82lbs

**Colors**  
Black

**HPRC6300W**

**internal dimension**  
921x279x243(mm)  
36.26x10.98x9.57(in)

**external dimension**  
970x335x285(mm)  
38.19x13.19x11.22(in)

**weight empty**  
5,70kg - 12.57lbs

**Colors**  
Black

**HPRC6400W**

**internal dimension**  
1081x279x243(mm)  
42.56x10.98x9.57(in)

**external dimension**  
1128x335x258(mm)  
44.41x13.19x11.22(in)

**weight empty**  
6,30kg - 13.89lbs

**Colors**  
Black

**HPRC6500W**

**internal dimension**  
1281x279x243(mm)  
50.43x10.98x9.57(in)

**external dimension**  
1330x335x285(mm)  
52.36x13.19x11.22(in)

**weight empty**  
7,20kg - 15.87lbs

**Colors**  
Black

**HPRC0500**

**dimension closed**  
394x280x27,5(mm)  
15.51x11.02x1.08(in)

**dimension open**  
464x350x27,5(mm)  
18.26x13.77x1.08(in)

**weight empty**  
empty: 0,95kg - 2.09lbs

**Colors**  
Black

Plaber S.r.l reserves the right to modify its products at any time and without notice, in order to better their quality and functionality. Therefore, all the information given in this datasheet is to be considered indicative and subject to possible modifications.





Photo by Roba Da Local



Photo by Flavio Oliva



Photo by Davide Marcesini



Photo by Martin Edström





H P R C C A S E S  
**MADE IN ITALY**  
M A N U F A C T U R E D

 Find us  
on Facebook

 Plabertalia  
Channel



**HPRC<sup>®</sup>**

**Plaber s.r.l. - HPRC cases**

Via Div Tridentina, 10  
I-36061 Bassano del Grappa  
Vicenza - Italy

Tel +39 0424 809150  
Fax +39 0424 808548

USA office and warehouse:

**Plaber America Inc - HPRC cases**

240 Anderson Avenue  
07074 Moonachie - New Jersey

Tel +1 201 617 2010  
Fax +1 201 617 2001

[www.hprc.it](http://www.hprc.it) | [www.hprcusa.com](http://www.hprcusa.com)  
[info@hprc.it](mailto:info@hprc.it)

HPRC<sup>®</sup> Brand owned by:

*plaber*  
I T A L I A