



2020 CASES WORKBOOK



H P R C C A S E S
MADE IN ITALY
M A N U F A C T U R E D

Our Brand

We're about happiness by cases. It means we're not just in the business of creating protective cases, even though that is what we do. Our everyday commitment is designed to make people happy.

From an ever-growing collection of innovative products to our passionate team who makes it happen, it's all about happiness.

Our Products

We're always looking for what's next. We're constantly innovating our original designed form and function, proving a fresh approach to the art of cases. By incorporating different styles, top quality materials and eye-catching patterns into our design, we make more than a case. We make a statement.

Our History

HPRC cases were born in 2006 with one simple premise: we can design a better case. In almost 10 years HPRC has grown into a successful international business, teaming up with important companies and partners. Our products can be found in 76 countries and have garnered top awards and praise. As we grow, our entrepreneurial spirit continues to drive the HPRC culture. After all, it's what helped us build one of the world's best hard cases brand.



Inside the R-Evolution

Revolution begins inside first: we start every day thinking different, exploring new ideas, projects and solutions. We work side by side in Italy, but we turn to people all around the world to inspire and get inspired.

We are involved in a constant revolution that goes hand in hand with the spirit of renewal of the brand. Our day-to-day commitment is to meet customer needs and personalize their journey. To do better, to offer the best.



Blue Bassano: new color, the best of us

Different color, new logo, refreshed style, best materials and services to look at the future.

Same quality and warranty provided.

HPRC is synonymous of change: a sense of urgency around the need of **R-Evolution**.

Ultralight. Watertight. Smart Cases.

HPRC cases can be used for all sorts of applications and different areas: photography, industrial, military, nautical, police and many others. HPRC provides total protection to the carried equipment against dust, water, impacts and corrosion for chemical agents.



Outdoor | Diving | Marine



Photo | Video





Industrial | Electronic | It



Photo by Luigi Freni

Military | Government



Photo by Flavio Oliva

Fire | Emergency | Medical

Highlights

STRUCTURAL AND VISUAL UPGRADING



New mechanics and engineering of the short sides which provide more resistance to the shell, greater light-weight and improved flexibility.



Refresh of the external surface with a wrinkle effect to the smoothed parts. A new professional and essential design which upgrades the aesthetic while improving the mechanical properties of the shell.



New Name Plate: larger in dimensions, more shock-resistant and refreshed in design.

ALL TERRAIN WHEELS SYSTEM



- cutting-edge innovation for a great grip
- use in any area and different weather conditions, ensuring versatility
- high performance in wet and dry conditions
- sure-footedness in a wide range of fields (asphalt, sand, stones, snow, porphyry)
- rolls smoothly for hundreds of miles
- more stability and enhanced safety
- easy wheels replacement
- increased wheels durability



Special soft cases

HPRC also produces different lines of soft cases and backpacks specifically designed to carry and protect the most popular drones of the market.



Committments

Our committment to you:

1.**UNDERSTAND** the problems of your market and your specific requirements. Through our expert knowledge of technological and economic trends we can offer an uncompromisingly individual approach to each customer.

2.**FIND** a transport solution tailored to your requirements. Our extensive cases range, our custom solutions that go far beyond our product offer, our team that assists you in selecting the case that is best suited to your own needs, are our core strengths.

3.**LISTEN** to and take account of your comments, through our network of experts and our frequent satisfaction surveys.

4.**BE** incessantly innovative and competitive in the professional cases market.

HPRC: innovation, technology and design.

Most of hard watertight cases are made in standard pp: our r&d department has developed an enhanced compound, still based on pp, now balanced with additional high performance resins. Ttx01® allows to produce cases which are lighter in weight and stronger in robustness. The special mix we added makes the HPRC shell thinner and more elastic, increasing therefore the shockproof degree and the lightweight. On the top of that, maintaining pp characteristics, HPRC cases are acidproof, scratchproof, able to resist to extreme weather conditions and temperature changes (all products are tested from - 40° c up to 80°c).



pole: ALU



body: TTX01® hardware: steel



wheels: PA66+PUR



handle: PP+SEBS



latches: POM



ext.handle: PA66GF30

Do you want to know more?
Please contact our technical team: tech@hprc.it



HPRC life time warranty: HPRC products have been built to rigorous standards of quality and are guaranteed against all defects in materials and workmanship for the whole life of the case.



Airex is the new automatic purge valve that is auto press release adjusted to changing environments automatically.

The attention and respect toward the environment and the commitment to an eco-sustainable future are important values for HPRC

 we case in **green.**

Our commitment starts from the design phase of the product, and involves all the production stages including the management of the impact of the product's end of life. All shells and components of HPRC cases are 100% recyclable: the production and transformation discards are infact reintegrated in the production cycle. The high resistance of the patented material ttx01® allows to use the HPRC cases longer than any other case, reducing therefore the emissions of CO2 due to the production

and distribution. The constant quest for suppliers complying with iso 14000 or emas certification and which are geographically close to our company is a contribute to reduce the environmental impact and represents a challenge in a world where firms usually aim only for low price suppliers not considering their possibly higher environmental impact. Moreover HPRC adopts renewable sources plants for energy production to cover the energetic needs.

Standard cases

HPRC cases are available with a standard setup if you don't need any special customization regarding the shell or the interior foam. Here are the 5 possible standard configurations.

* CUBED FOAM - USA: F



* EMPTY - USA: E



* SOFT PADDED OPEN DECK + DIVIDERS - USA: DK



* INTERIOR BAG - USA: IC



* SECOND SKIN - USA: SK



* PANEL FRAME MOUNTING SYSTEM AVAILABLE

Oem cases

We are cases producers,
if you do not find the right size or best liked design
we will make a customized case for you

1. Product inquiry >>>> Mold + price offer
2. Contract signing >>>> Design drawing
3. Client confirmation >>>> Mold making
4. Sample checking >>>> Production arrangement

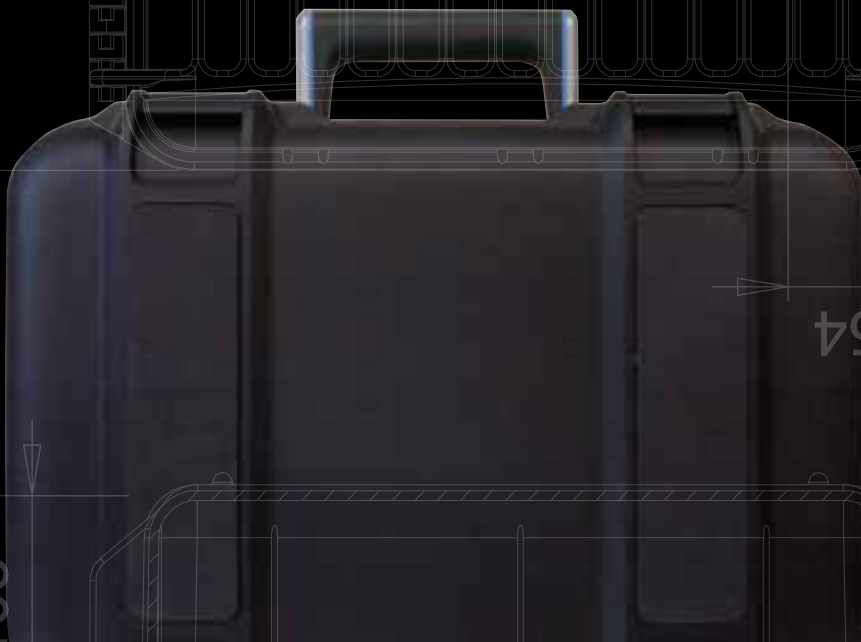

377

340

4

103

54

105

1.5

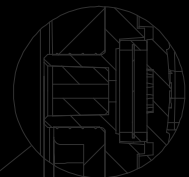

Custom fit cases

Customization concerns: color, printing, adhesive, foam inlay (die cut, water cut, milled, moulded), thermoformed inlay, lid panels and organizer, extra working on the cases shell (holes, external applications) keeping the water tightness.



HIGH VISIBILITY INLAYS

A special high visibility inlay can be designed in order to avoid forgetting equipment on the field after use.



CUSTOMIZED LAYOUT

We give customers different equipment layouts options in order to optimize space and handiness.



CUSTOMIZED COVERS

Customization also includes the possibility to design solutions in order to use the cover as a glove compartment. We can provide organizers, special tools addition, shell modifications and custom colors.



SHELL CUSTOMIZATION

HPRC customization service also provides shell customization, including holes for external connections.

HPRC panel frame accessory (HPRCPF) allows customers to install a control panel into the case, ensuring a perfect fit.



INJECTION INLAYS

The custom inlay made in expanded polypropylene of different densities guarantees a perfect protection and a professional look to the case. Our service includes the initial study of the mould and goes through the prototype phase and final production.



MILLED FOAMS

The milling technology allows to get one piece inlays with many different depths.



WATER CUTTING TECHNOLOGY FOAMS

Expanded polyethylene foams are available in various densities (Kg/m³), resistance to compression (kPal) and resistance to different temperatures ranges (°C). These foams, produced with water cutting technology, guarantee a good protection and allow a wide range of customizations.



MULTY LAYER

A multi layer case is a handy solution, especially when equipment is made of many small and different parts that must be stored and protected into one case only.

HPRC 1100



* open cases images reflect the different HPRC cases internal options

TECHNICAL FEATURES

Dimension:

internal dimension 57x58x25,5(mm) - 2.24x2.28x1.00(in)
external dimension 69x80x32(mm) - 2.72x3.15x1.26(in)



lid: 12,8(mm) - 0.50(in) bottom: 12,7(mm) - 0.50(in)

Weight:

empty: 0,04kg - 0.09lbs

available empty or with memory card storage

Temperature rating:

Minimum Maximum
-40°C -40°F +80°C +176°F

Colors:

Black - Ferrari red

TECHNICAL DRAWING

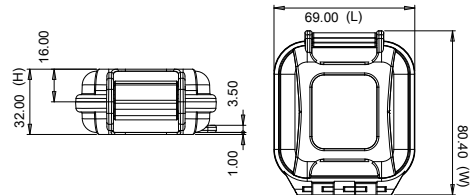

APPROVALS
ATA 300
IP67
STANAG 4280
DS 81-41

TEST
DROP
IMPACT
HANDLE
WATERTIGHT INTEGRITY
UV COLOR AND MATERIAL
PROTECTION



* memory card case

* empty case

FEATURES

- Removable multiformat memory card holder
- Accepted card Formats:
 - 2 of SD cards
 - 1 of XQD card
 - 1 of CF card
- Full/empty indicator



Both models with our trademark "Full - Empty" switch: just flip the arrow towards the desired E-F position and get straight access to your cards.

* open cases images reflect the different HPRC cases internal options



TECHNICAL FEATURES

Dimension:

internal dimension 116x67x25,5(mm) - 4.57x2.64x1.00(in)
external dimension 127x90x32(mm) - 5.00x3.54x1.26(in)



lid: 12,8(mm) - 0.50(in) bottom: 12,7(mm) - 0.50(in)

Weight:

empty: 0,09kg - 0.19lbs

available empty or with memory card storage

Temperature rating:

Minimum Maximum
-40°C -40°F +80°C +176°F

Colors:

Black - Ferrari red

TECHNICAL DRAWING

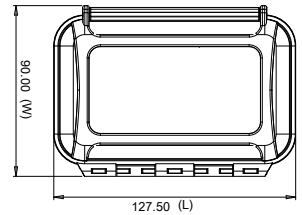
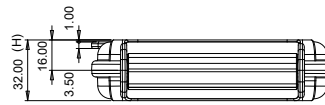

* cubed foam



* memory card case



* memory Card Case for video



APPROVALS
ATA 300
IP67
STANAG 4280
DS 81-41

TEST
DROP
IMPACT
HANDLE
WATERTIGHT INTEGRITY
UV COLOR AND MATERIAL
PROTECTION



FEATURES

- Removable multiformat memory card holder
- Accepted card Formats:
 - **8 of SD cards**
 - **4 of XQD cards**
 - **4 of CF cards**
- Full/empty indicator



HPRC 1400

NEW



* open cases images reflect the different HPRC cases internal options

TECHNICAL FEATURES

Dimension:

internal dimension 180x110x40(mm) - 7,08x4,33x1,57(in)
external dimension 200x142x48(mm) - 7,87x5,59x1,88(in)



lid: 20(mm) - 0,78(in) bottom: 20(mm) - 0,78(in)

Weight:

empty: 0,60kg - 1,32lbs
available empty or with cubed foam

Temperature rating:

Minimum Maximum
-40°C -40°F +80°C +176°F

Colors:

Black

TECHNICAL DRAWING

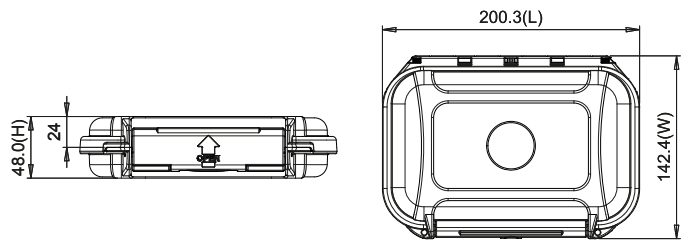

* empty



* cubed foam



APPROVALS
ATA 300
IP67
STANAG 4280
DS 81-41

TEST
DROP
IMPACT
HANDLE
WATERTIGHT INTEGRITY
UV COLOR AND MATERIAL
PROTECTION





HPRC 2100



* open cases images reflect the different HPRC cases internal options

TECHNICAL FEATURES

Dimension:

internal dimension 210x145x94(mm) - 8.27x5.71x3.70(in)
external dimension 235x196x110(mm) - 9.25x7.72x4.33(in)



lid: 18(mm) - 0.71(in) bottom: 76(mm) - 2.99(in)

Weight:

empty: 0,76kg - 1.68lbs
with cubed foam: 0,84kg - 1.85lbs

Temperature rating:

Minimum Maximum
-40°C -40°F +80°C +176°F

Colors:

Black - Orange - Ferrari red - Electric blue

TECHNICAL DRAWING

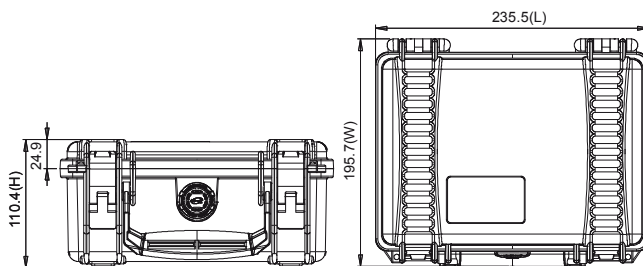

* cubed foam



* interior bag



APPROVALS
ATA 300
IP67
STANAG 4280
DS 81-41

TEST
DROP
IMPACT
HANDLE
WATERTIGHT INTEGRITY
UV COLOR AND MATERIAL
PROTECTION



ACCESSORIES

HPRCCUB2100
CUBED FOAM
USA:HPRCFO (foam only)



HPRCLO708TSA-1
PADLOCK - TSA



HPRCBAG2100
INTERIOR BAG
USA:HPRCIC (internal case)



HPRCPF-001-01
PANEL FRAME
(panel not included)



* open cases images reflect the different HPRC cases internal options



TECHNICAL FEATURES

Dimension:

internal dimension 236x182x108(mm) - 9.29x7.17x4.25(in)
external dimension 258x230x123(mm) - 10.16x9.06x4.84(in)



lid: 29(mm) - 1.14(in) bottom: 79(mm) - 3.11(in)

Weight:

empty: 0,87kg - 1.92lbs
with cubed foam: 1,08kg - 2.38lbs

Temperature rating:

Minimum -40°C -40°F Maximum +80°C +176°F

Colors:

Black

TECHNICAL DRAWING

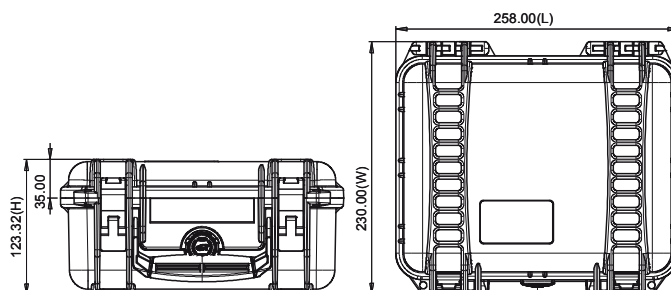

* cubed foam



* interior bag



APPROVALS
ATA 300
IP67
STANAG 4280
DS 81-41

TEST
DROP
IMPACT
HANDLE
WATERTIGHT INTEGRITY
UV COLOR AND MATERIAL
PROTECTION



ACCESSORIES

HPRCCUB2200
CUBED FOAM
USA:HPRCFO (foam only)



HPRCL0708TSA-1
PADLOCK - TSA



HPRCBAG2200
INTERIOR BAG
USA:HPRCIC (internal case)



HPRCPF-002-01
PANEL FRAME
(panel not included)



HPRC 2250



TECHNICAL FEATURES

Dimension:

internal dimension 236x182x155(mm) - 9.29x7.17x6.10(in)
external dimension 258x230x170(mm) - 10.16x9.06x6.69(in)



lid: 29(mm) - 1.14(in) bottom: 126(mm) - 4.96(in)

Weight:

empty: 1,00kg - 2.20lbs
with cubed foam: 1,35kg - 2.97lbs

Temperature rating:

Minimum -40°C -40°F Maximum +80°C +176°F

Colors:

Black

TECHNICAL DRAWING

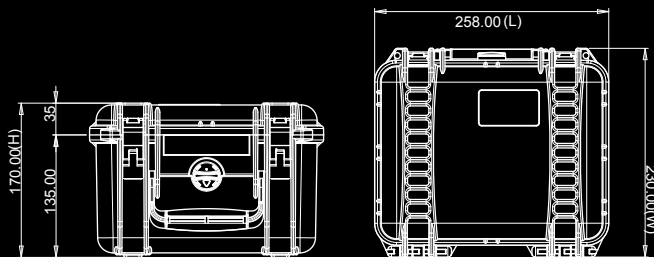

* cubed foam



* interior bag



APPROVALS
ATA 300
IP67
STANAG 4280
DS 81-41

TEST
DROP
IMPACT
HANDLE
WATERTIGHT INTEGRITY
UV COLOR AND MATERIAL
PROTECTION



ACCESSORIES

HPRCCUB2250
CUBED FOAM
USA:HPRCFO (foam only)

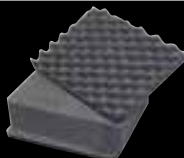

HPRCLO708TSA-1
PADLOCK - TSA



HPRCBAG2250
INTERIOR BAG
USA:HPRCIC (internal case)



HPRCPF-002-01
PANEL FRAME
(panel not included)



* open cases images reflect the different HPRC cases internal options



TECHNICAL FEATURES

Dimension:

internal dimension 304x231x137(mm) - 11.97x9.09x5.39(in)
external dimension 335x289x155(mm) - 13.19x11.38x6.10(in)



lid: 31(mm) - 1.22(in) bottom: 106(mm) - 4.17(in)

Weight:

empty: 1,67kg - 3.68lbs
with cubed foam: 1,90kg - 4.19lbs

Temperature rating:

Minimum -40°C -40°F Maximum +80°C +176°F

Colors:

Black - Orange - Ferrari red - Electric blue

TECHNICAL DRAWING

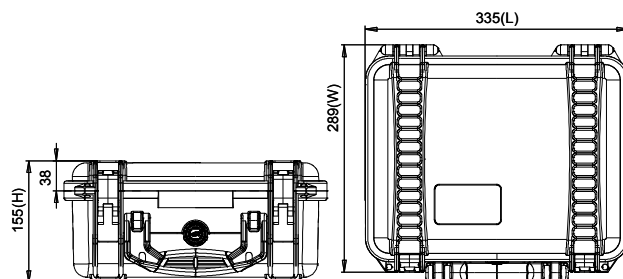

* cubed foam



* interior bag



APPROVALS
ATA 300
IP67
STANAG 4280
DS 81-41

TEST
DROP
IMPACT
HANDLE
WATERTIGHT INTEGRITY
UV COLOR AND MATERIAL
PROTECTION



ACCESSORIES

HPRCCUB2300
CUBED FOAM
USA:HPRCFO (foam only)



HPRCLO708TSA-1
PADLOCK - TSA



HPRCBAG2300
INTERIOR BAG
USA:HPRCIC (internal case)



HPRCPF-003-01
PANEL FRAME
(panel not included)



HPRC 2350



* open cases images reflect the different HPRC cases internal options

TECHNICAL FEATURES

Dimension:

internal dimension 340x235x99(mm) - 13.38x9.25x3.90(in)
external dimension 365x290x115(mm) - 14.37x11.42x4.53(in)



lid: 29(mm) - 1.14(in) bottom: 70(mm) - 2.75(in)



Weight:

empty: 1.48kg - 3.25lbs
with cubed foam: 1.66kg - 3.65lbs

Temperature rating:

Minimum -40°C -40°F Maximum +80°C +176°F

Colors:

Black

TECHNICAL DRAWING

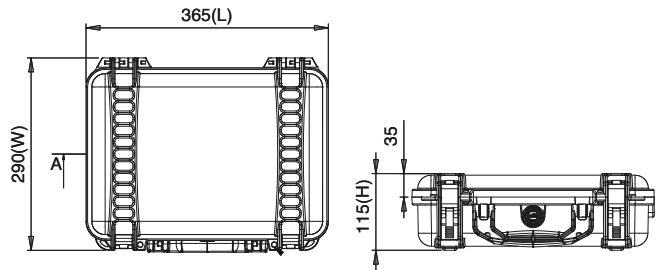

* cubed foam



APPROVALS

ATA 300
IP67
STANAG 4280
DS 81-41

TEST

DROP
IMPACT
HANDLE
WATERTIGHT INTEGRITY
UV COLOR AND MATERIAL
PROTECTION



ACCESSORIES

HPRCCF2350
CUBED FOAM
USA:HPRCFO (foam only)



HPRCL0708TSA-1
PADLOCK - TSA





PRADA

PRADA

PRADA
Dc
C4

PRADA
Bc
1

PRADA
C4

PRADA
Aa
C4

PRADA
Aa
C4

HPRC 2400



* open cases images reflect the different HPRC cases internal options

TECHNICAL FEATURES

Dimension:

internal dimension 380x266x152(mm) - 14.96x10.47x5.98(in)
external dimension 405x330x170(mm) - 15.94x12.99x6.69(in)



lid: 45(mm) - 1.77(in) bottom: 107(mm) - 4.21(in)

Weight:

empty: 2,05kg - 4.52lbs
with cubed foam: 2,38kg - 5.25lbs



Temperature rating:

Minimum -40°C -40°F Maximum +80°C +176°F

Colors:

Black - Orange - Ferrari red - Electric blue

TECHNICAL DRAWING

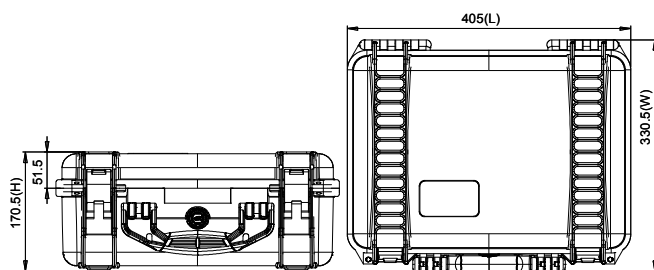

<p>* cubed foam</p>	<p>* interior bag</p>	<p>APPROVALS ATA 300 IP67 STANAG 4280 DS 81-41</p> <p>TEST DROP IMPACT HANDLE WATERTIGHT INTEGRITY UV COLOR AND MATERIAL PROTECTION</p>



ACCESSORIES

<p>HPRCCUB2400 CUBED FOAM USA:HPRCFO (foam only)</p>	<p>HPRCLO708TSA-1 PADLOCK - TSA</p>	<p>HPRCBAG2400 INTERIOR BAG USA:HPRCIC (internal case)</p>	<p>HPRCORG2400 LID ORGANIZER</p>	<p>HPRCPF-004-01 PANEL FRAME (panel not included)</p>
---------------------------------------------------------------------	------------------------------------------------	---------------------------------------------------------------------------	---------------------------------------------	----------------------------------------------------------------------

* open cases images reflect the different HPRC cases internal options



TECHNICAL FEATURES

Dimension:

internal dimension 409x306x175(mm) - 16.10x12.05x6.89(in)
external dimension 434x371x193(mm) - 17.09x14.61x7.60(in)



lid: 70(mm) - 2.76(in) bottom: 105(mm) - 4.14(in)

Weight:

empty: 2,60kg - 5.73lbs
with cubed foam: 3,14kg - 6.92lbs

Temperature rating:

Minimum -40°C -40°F Maximum +80°C +176°F

Colors:

Black

TECHNICAL DRAWING

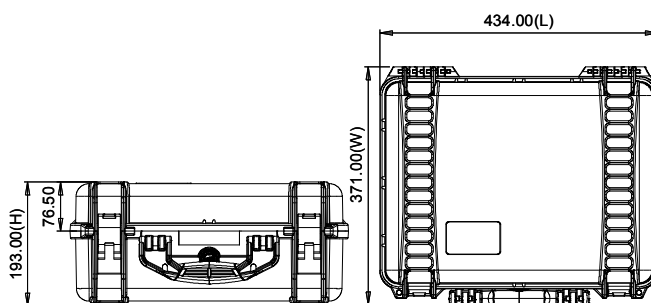

* cubed foam



* interior bag



APPROVALS
ATA 300
IP67
STANAG 4280
DS 81-41

TEST
DROP
IMPACT
HANDLE
WATERTIGHT INTEGRITY
UV COLOR AND MATERIAL
PROTECTION



ACCESSORIES

<p>HPRCCUB2460 CUBED FOAM USA:HPRCFO (foam only)</p> 	<p>HPRCL0708TSA-1 PADLOCK - TSA</p> 	<p>HPRCBAG2460 INTERIOR BAG USA:HPRCIC (internal case)</p> 	<p>HPRCORG2460 LID ORGANIZER</p> 	<p>HPRCPF-005-01 PANEL FRAME (panel not included)</p> 
--------------------------------------------------------------------------------------------------------------------------------------------------------	------------------------------------------------------------------------------------------------------------------------------------	---------------------------------------------------------------------------------------------------------------------------------------------------------------	---------------------------------------------------------------------------------------------------------------------------------	-----------------------------------------------------------------------------------------------------------------------------------------------------------

HPRC 2500



* open cases images reflect the different HPRC cases internal options

TECHNICAL FEATURES

Dimension:
internal dimension 450x323x175(mm) - 17.72x12.72x6.89(in)
external dimension 478x390x194(mm) - 18.82x15.35x7.64(in)



lid: 46(mm) - 1.81(in) bottom: 129(mm) - 5.08(in)



Weight:
empty: 3,15kg - 6.94lbs
with cubed foam: 3,71kg - 8.18lbs

Temperature rating:
Minimum -40°C -40°F Maximum +80°C +176°F

Colors:
Black - Orange - Ferrari red - Electric blue

TECHNICAL DRAWING

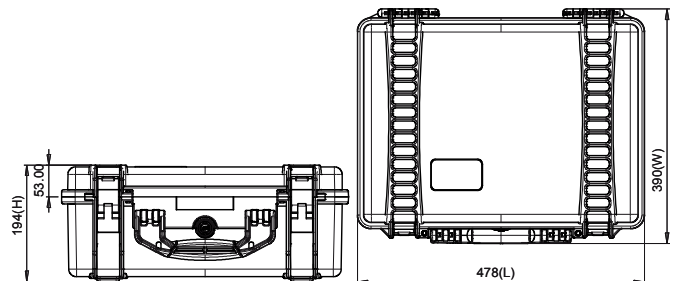

* cubed foam	* interior bag	* soft padded open deck + dividers	APPROVALS ATA 300 IP67 STANAG 4280 DS 81-41	TEST DROP IMPACT HANDLE WATERTIGHT INTEGRITY UV COLOR AND MATERIAL PROTECTION	 	

ACCESSORIES

HPRCCUB2500 CUBED FOAM USA:HPRCFO (foam only)	HPRCLO708TSA-1 PADLOCK - TSA	HPRCBAG2500 INTERIOR BAG USA:HPRCIC (internal case)	HPRCORG2500 LID ORGANIZER	HPRCPF-006-01 PANEL FRAME (panel not included)	HPRCSFD2500 SOFT PADDED OPEN DECK + DIVIDERS USA: HPRCDK (divider kit)

* open cases images reflect the different HPRC cases internal options



TECHNICAL FEATURES

Dimension:

internal dimension 513x288x132(mm) - 20.20x11.34x5.20(in)
external dimension 540x350x153(mm) - 21.26x13.78x6.02(in)



lid: 46(mm) - 1.81(in) bottom: 86(mm) - 3.25(in)

Weight:

empty: 3,20kg - 7.05lbs
with cubed foam: 3,26kg - 7.19lbs

Temperature rating:

Minimum -40°C -40°F Maximum +80°C +176°F

Colors:

Black

TECHNICAL DRAWING

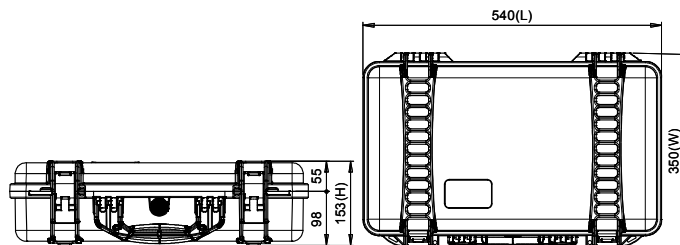

* cubed foam	* soft padded open deck + dividers	* interior bag	APPROVALS ATA 300 IP67 STANAG 4280 DS 81-41 TEST DROP IMPACT HANDLE WATERTIGHT INTEGRITY UV COLOR AND MATERIAL PROTECTION lt volume in litres wheeled

ACCESSORIES

HPRCCUB2530 CUBED FOAM USA:HPRCFO (foam only)	HPRCLO708TSA-1 PADLOCK - TSA	HPRCBAG2530 INTERIOR BAG USA:HPRCIC (internal case)	HPRCSTRAP	HPRCORG2530 LID ORGANIZER	HPRCSFD2530 SOFT PADDED OPEN DECK + DIVIDERS USA: HPRCDK (divider kit)

HPRC 2550W



* open cases images reflect the different HPRC cases internal options

TECHNICAL FEATURES

Dimension:

internal dimension 513x288x200(mm) - 20.19x11.34x7.87(in)
external dimension 549x346x236(mm) - 21.61x13.62x9.29(in)



lid: 48(mm) - 1.88(in) bottom: 152(mm) - 5.98(in)



Weight:
empty: 4.35kg - 9.57lbs



Temperature rating:

Minimum -40°C -40°F Maximum +80°C +176°F

Colors:

Black - Orange - Ferrari red - Electric blue - Gravel Grey

TECHNICAL DRAWING

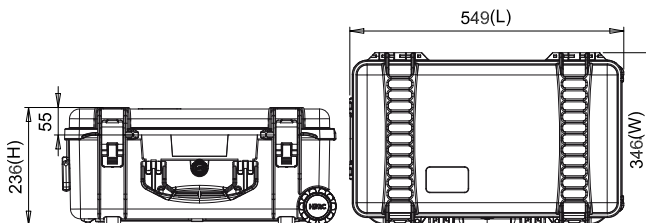

<p>* cubed foam</p>	<p>* interior bag</p>	<p>* second skin</p>	<p>APPROVALS ATA 300 IP67 STANAG 4280 DS 81-41</p> <p>TEST DROP IMPACT HANDLE WATERTIGHT INTEGRITY UV COLOR AND MATERIAL PROTECTION</p> <p>lt volume in litres wheeled</p>

ACCESSORIES

<p>HPRCCUB2550W CUBED FOAM USA:HPRCFO (foam only)</p>	<p>HPRCLO708TSA-1 PADLOCK - TSA</p>	<p>HPRCBAG2550W-01 INTERIOR BAG USA:HPRCIC (internal case)</p>	<p>HPRCORG-004-01 LID ORGANIZER</p>	<p>HPRCSSK2550W-01 SECOND SKIN</p>	
----------------------------------------------------------------------	------------------------------------------------	-------------------------------------------------------------------------------	------------------------------------------------	-----------------------------------------------	--

* open cases images reflect the different HPRC cases internal options



TECHNICAL FEATURES

Dimension:

internal dimension 390x310x89(mm) - 15.35x12.20x3.50(in)
external dimension 410x359x110(mm) - 16.14x14.13x4.33(in)



lid: 44(mm) - 1.73(in) bottom: 45(mm) - 1.77(in)

Weight:

empty: 2,40kg - 5.29lbs
with cubed foam: 2,57kg - 5.67lbs



Temperature rating:

Minimum -40°C -40°F Maximum +80°C +176°F



Colors:

Black

TECHNICAL DRAWING

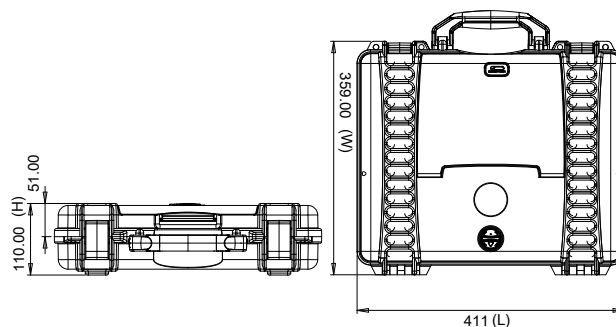

<p>* cubed foam</p>	<p>* interior bag</p>		<p>APPROVALS ATA 300 IP67 STANAG 4280 DS 81-41</p> <p>TEST DROP IMPACT HANDLE WATERTIGHT INTEGRITY UV COLOR AND MATERIAL PROTECTION</p> <p>lt volume in litres wheeled</p>

ACCESSORIES

<p>HPRCCUB2580 CUBED FOAM USA:HPRCFO (foam only)</p>	<p>HPRCLO708TSA-1 PADLOCK - TSA</p>	<p>HPRCSTRAP</p>	<p>HPRCORG2580 LID ORGANIZER</p>
---------------------------------------------------------------------	------------------------------------------------	-------------------------	---------------------------------------------

HPRC 2600



* open cases images reflect the different HPRC cases internal options

TECHNICAL FEATURES

Dimension:

internal dimension 482x358x198(mm) - 18.97x14.09x7.79(in)
external dimension 543x419x218(mm) - 21.37x16.49x8.58(in)

lt34

lid: 46(mm) - 1.81(in) bottom: 152(mm) - 5.98(in)

Weight:

empty: 4,25kg - 9.37lbs
with cubed foam: 5,05kg - 11.13lbs

Temperature rating:

Minimum -40°C -40°F Maximum +80°C +176°F

Colors:

Black - Orange - Ferrari red - Electric blue

TECHNICAL DRAWING

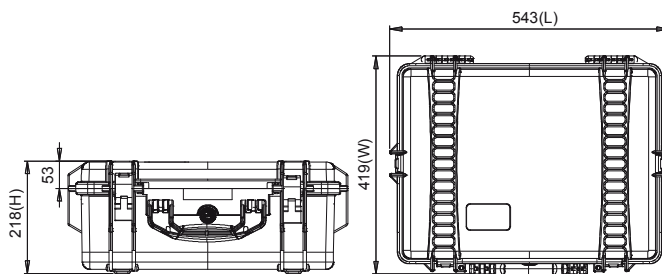

* cubed foam	* interior bag	* second skin	APPROVALS ATA 300 IP67 STANAG 4280 DS 81-41	TEST DROP IMPACT HANDLE WATERTIGHT INTEGRITY UV COLOR AND MATERIAL PROTECTION	 	

ACCESSORIES

HPRCCUB2600 CUBED FOAM USA:HPRCFO (foam only)	HPRCLO708TSA-1 PADLOCK - TSA	HPRCBAG2600 INTERIOR BAG USA:HPRCIC (internal case)	HPRCORG2600 LID ORGANIZER	HPRCPF-007-01 PANEL FRAME (panel not included)	HPRCSSK2600-01 SECOND SKIN

HPRC 2600W



* open cases images reflect the different HPRC cases internal options

TECHNICAL FEATURES

Dimension:

internal dimension 482x358x218(mm) - 18.98x14.09x8.58(in)
external dimension 546x423x250(mm) - 21.05x16.65x9.84(in)

lt38

lid: 46(mm) - 1.81(in) bottom: 172(mm) - 6.77(in)

W

Weight:

empty: 6,05kg - 13.34lbs
with cubed foam: 6,97kg - 15.37lbs

Temperature rating:

Minimum -40°C -40°F Maximum +80°C +176°F

Colors:

Black - Orange - Electric blue - Gravel Grey

TECHNICAL DRAWING

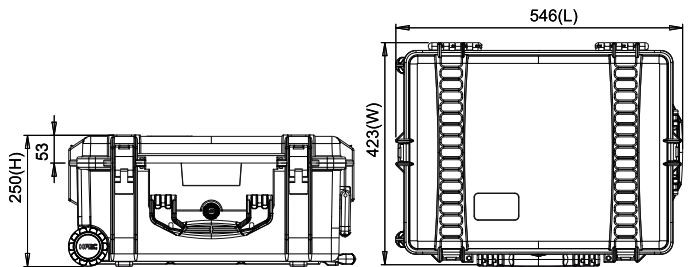

* cubed foam	* interior bag	* second skin	APPROVALS ATA 300 IP67 STANAG 4280 DS 81-41	TEST DROP IMPACT HANDLE WATERTIGHT INTEGRITY UV COLOR AND MATERIAL PROTECTION	lt volume in litres wheeled	

ACCESSORIES

HPRCCUB2600W CUBED FOAM USA:HPRCFO (foam only)	HPRCLO708TSA-1 PADLOCK - TSA	HPRCBAG600W INTERIOR BAG USA:HPRCIC (internal case)	HPRCORG2600W LID ORGANIZER	HPRCPF-008-01 PANEL FRAME (panel not included)	HPRCSSK2600W-01 SECOND SKIN

HPRC 2700



TECHNICAL FEATURES

Dimension:

internal dimension 555x459x205(mm) - 21.85x18.07x8.07(in)
external dimension 617x525x227(mm) - 24.29x20.67x8.94(in)



lid: 45(mm) - 1.77(in) bottom: 160(mm) - 6.29(in)

Weight:

empty: 5,55kg - 12.24lbs
with cubed foam: 6,71kg - 14.79lbs

Temperature rating:

Minimum Maximum
-40°C -40°F +80°C +176°F

Colors:

Black - Orange - Ferrari red

TECHNICAL DRAWING

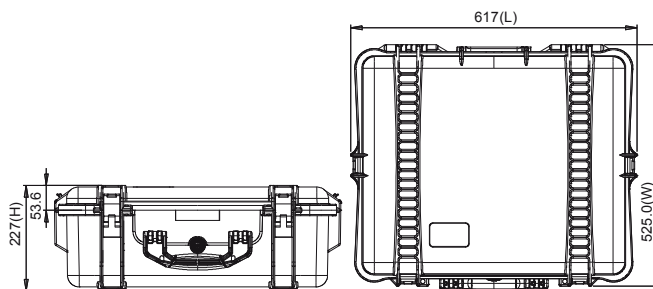

			<p>APPROVALS ATA 300 IP67 STANAG 4280 DS 81-41</p> <p>TEST DROP IMPACT HANDLE WATERTIGHT INTEGRITY UV COLOR AND MATERIAL PROTECTION</p> <p>lt volume in litres wheeled</p>
* cubed foam	* interior bag		

ACCESSORIES

<p>HPRCCUB2700 CUBED FOAM USA:HPRCFO (foam only)</p>	<p>HPRCLO708TSA-1 PADLOCK - TSA</p>	<p>HPRCBAG2700 INTERIOR BAG USA:HPRCIC (internal case)</p>	<p>HPRCORG2700 LID ORGANIZER</p>	<p>HPRCPF-004-01 PANEL FRAME (panel not included)</p>
---------------------------------------------------------------------	------------------------------------------------	---------------------------------------------------------------------------	---------------------------------------------	----------------------------------------------------------------------

* open cases images reflect the different HPRC cases internal options

HPRC 2700W

* open cases images reflect the different HPRC cases internal options



TECHNICAL FEATURES

Dimension:

internal dimension 555x459x256(mm) - 21.85x18.07x10.08(in)
external dimension 620x525x280(mm) - 24.41x20.67x11.02(in)

lt65

lid: 45(mm) - 1.77(in) bottom: 211(mm) - 8.30(in)

W

Weight:

empty: 8,30kg - 18.30lbs
with cubed foam: 9,07kg - 19.99lbs

Temperature rating:

Minimum Maximum
-40°C -40°F +80°C +176°F

Colors:

Black - Orange - Ferrari red - Gravel Grey

TECHNICAL DRAWING

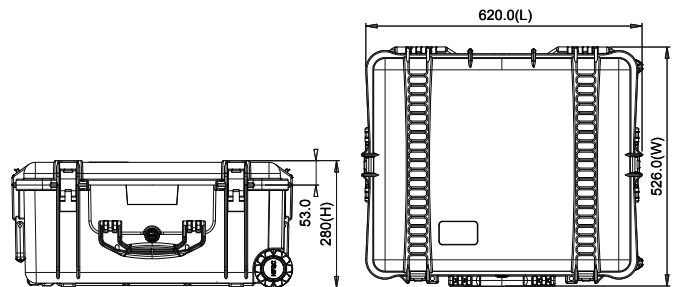

* cubed foam



* interior bag



* second skin



APPROVALS
ATA 300
IP67
STANAG 4280
DS 81-41

TEST
DROP
IMPACT
HANDLE
WATERTIGHT INTEGRITY
UV COLOR AND MATERIAL
PROTECTION

lt volume in litres
w wheeled

ACCESSORIES

HPRCCUB2700W
CUBED FOAM
USA:HPRCFO (foam only)



HPRCL0708TSA-1
PADLOCK - TSA



HPRCBAG2700W
INTERIOR BAG
USA:HPRCIC (internal case)



HPRCORG2700W
LID ORGANIZER



HPRCSSK2700W-01
SECOND SKIN



HPRCPF-004-01
PANEL FRAME
(panel not included)



HPRC 2710



TECHNICAL FEATURES

Dimension:
 internal dimension 555x459x256(mm) - 21.85x18.07x10.08(in)
 external dimension 617x525x280(mm) - 24.29x20.67x11.02(in)



lid: 45(mm) - 1.77(in) bottom: 211(mm) - 8.30(in)

Weight:
 empty: 6.71kg - 14.76lbs

Temperature rating:
 Minimum -40°C -40°F Maximum +80°C +176°F

Colors:
 Black

TECHNICAL DRAWING

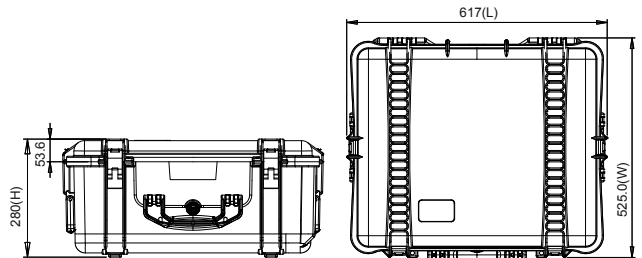

* cubed foam



APPROVALS
 ATA 300
 IP67
 STANAG 4280
 DS 81-41

TEST
 DROP
 IMPACT
 HANDLE
 WATERTIGHT INTEGRITY
 UV COLOR AND MATERIAL
 PROTECTION



ACCESSORIES

HPRCCUB2710 CUBED FOAM USA:HPRCFO (foam only)	HPRCLO708TSA-1 PADLOCK - TSA	HPRCPF-004-01 PANEL FRAME (panel not included)	HPRCORG2710 LID ORGANIZER

* open cases images reflect the different HPRC cases internal options

* open cases images reflect the different HPRC cases internal options

HPRC 2730W



TECHNICAL FEATURES

Dimension:

internal dimension 509x460x316(mm) - 20.04x18.11x12.44(in)
external dimension 620x520x350(mm) - 24.41x20.47x13.78(in)

lid: 45(mm) - 1.77(in) bottom: 271(mm) - 10.66(in)

Weight:

empty: 7,55kg - 16.64lbs
with cubed foam: 10,43kg - 22.99lbs

Temperature rating:

Minimum -40°C -40°F Maximum +80°C +176°F

Colors:

Black



TECHNICAL DRAWING

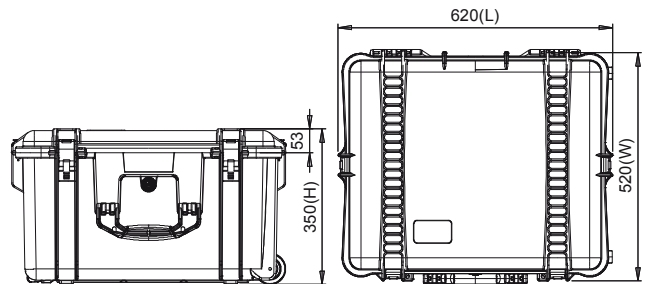

* cubed foam	* interior bag	* soft padded open deck + dividers	APPROVALS ATA 300 IP67 STANAG 4280 DS 81-41	TEST DROP IMPACT HANDLE WATERTIGHT INTEGRITY UV COLOR AND MATERIAL PROTECTION	* volume in litres	

ACCESSORIES

HPRCCUB2730W CUBED FOAM USA:HPRCFO (foam only)	HPRCLO708TSA-1 PADLOCK - TSA	HPRCBAG2730W INTERIOR BAG USA:HPRCIC (internal case)	HPRCORG2730W LID ORGANIZER	HPRCSFD2730W SOFT PADDED OPEN DECK + DIVIDERS USA: HPRCDK (divider kit)

HPRC 2745W

NEW



TECHNICAL FEATURES

Dimension:

internal dimension 771x401x247(mm) - 30.35x15.78x9.72 (in)
external dimension 822x452x294(mm) - 32.36x17.79x11.57 (in)



lid 52(mm) - 2.04(in) bottom: 195(mm) - 7.68(in)

Weight:

empty: 7.05kg – 15.6lbs

Temperature rating:

Minimum -40°C -40°F Maximum +80°C +176°F

Colors:

Black, Gravel Grey

TECHNICAL DRAWING

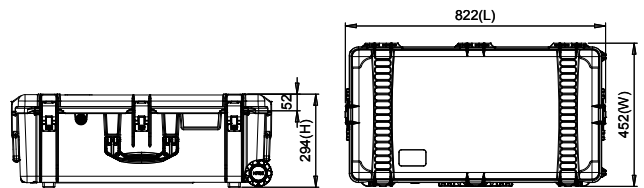

* empty



* cubed foam



APPROVALS
ATA 300
IP67
STANAG 4280
DS 81-41

TEST
DROP
IMPACT
HANDLE
WATERTIGHT INTEGRITY
UV COLOR AND MATERIAL
PROTECTION



ACCESSORIES

HPRCCUB2745W
CUBED FOAM
USA:HPRCFO (foam only)



HPRCLO708TSA-1
PADLOCK - TSA



* open cases images reflect the different HPRC cases internal options



HPRC 2760W



When innovation becomes a case

Main features:

- 4 built in wheels: roll the case along by simply pushing it while it's on the ground
- two side handles: push or pull the case as a trolley
- stackable exterior lid design: use the case as a cart by stacking more cases on top of each other
- two lateral handles: when you need to hold the case from both sides
- comfortable soft-grip handle
- braked wheels to prevent unexpected movement



HPRC 2760W

* open cases images reflect the different HPRC cases internal options



TECHNICAL FEATURES

Dimension:

internal dimension 690x450x300(mm) - 27.16x17.71x11.81(in)
external dimension 750x510x329(mm) - 29.53x20.08x12.99(in)

lt91

lid: 50(mm) - 1.97(in) bottom: 250(mm) - 9.84(in)

W

Weight:

empty: 9,20kg - 20.28lbs
with cubed foam: 10,72kg - 23.63lbs

Temperature rating:

Minimum Maximum
-40°C -40°F +80°C +176°F

Colors:

Black

TECHNICAL DRAWING

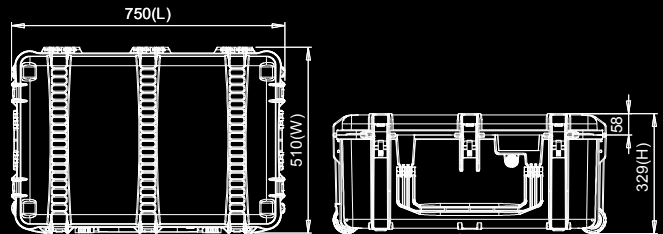

* cubed foam



* interior bag



* soft padded open deck + dividers



APPROVALS
ATA 300
IP67
STANAG 4280
DS 81-41

TEST
DROP
IMPACT
HANDLE
WATERTIGHT INTEGRITY
UV COLOR AND MATERIAL
PROTECTION

lt91 volume in litres

W

ACCESSORIES

HPRCCUB2760W
CUBED FOAM
USA:HPRCFO (foam only)



HPRCLO708TSA-1
PADLOCK - TSA



HPRCBAG2760W
Interior bag
USA:HPRCIC (internal case)



HPRCSFD2760W SOFT PADDED
OPEN DECK + DIVIDERS USA:
HPRCDK (divider kit)



HPRC 2780W



* open cases images reflect the different HPRC cases internal options

TECHNICAL FEATURES

Dimension:

internal dimension 749x525x366(mm) - 29.49x20.67x14.41(in)
external dimension 810x586,5x388(mm) - 31.89x23.09x15.28(in)

It 142

W

lid: 73(mm) - 2.87(in) bottom: 293(mm) - 11.53(in)

Weight:

empty: 12,20kg - 26.90lbs
with cubed foam: 16,18kg - 35.67lbs

Temperature rating:

Minimum -40°C -40°F Maximum +80°C +176°F

Colors:

Black

TECHNICAL DRAWING

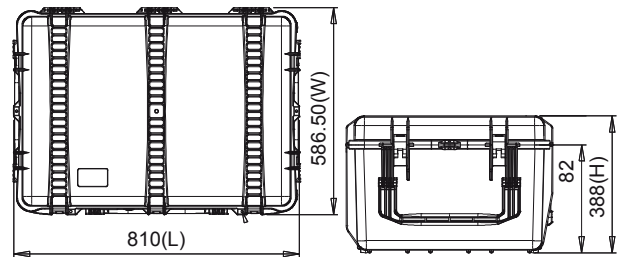

* cubed foam	* interior bag	* soft padded open deck + dividers	APPROVALS ATA 300 IP67 STANAG 4280 DS 81-41	TEST DROP IMPACT HANDLE WATERTIGHT INTEGRITY UV COLOR AND MATERIAL PROTECTION	It volume in litres wheeled	

ACCESSORIES

HPRCCUB2780W CUBED FOAM USA:HPRCFO (foam only)	HPRCLO708TSA-1 PADLOCK - TSA	HPRCBAG2780W INTERIOR BAG USA:HPRCIC (internal case)	HPRCORG2780W LID ORGANIZER	HPRCSFD2780W SOFT PADDED OPEN DECK + DIVIDERS USA: HPRCDK (divider kit)

HPRC 2800W

* open cases images reflect the different HPRC cases internal options



TECHNICAL FEATURES

Dimension:

internal dimension 749x525x455(mm) - 29.49x20.67x17.91(in)
external dimension 810x586,5x479(mm) - 31.89x23.09x18.86(in)



lid: 73(mm) - 2.87(in) bottom: 382(mm) - 15.03(in)



Weight:

empty: 13,20kg - 29.10lbs
with cubed foam: 17,43kg - 38.43lbs

Temperature rating:

Minimum -40°C -40°F Maximum +80°C +176°F

Colors:

Black

TECHNICAL DRAWING

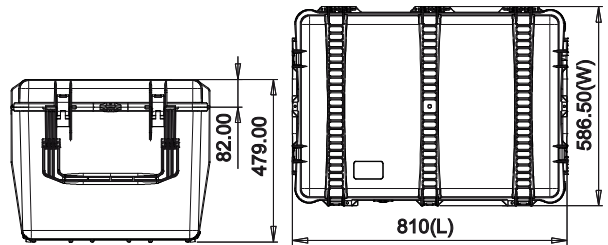

* cubed foam

* interior bag

* soft padded open deck + dividers



APPROVALS
ATA 300
IP67
STANAG 4280
DS 81-41

TEST
DROP
IMPACT
HANDLE
WATERTIGHT INTEGRITY
UV COLOR AND MATERIAL
PROTECTION



179 volume in litres

W wheeled

ACCESSORIES

HPRCCUB2800W
CUBED FOAM
USA:HPRCFO (foam only)

HPRCLO708TSA-1
PADLOCK - TSA

HPRCBAG2800W
INTERIOR BAG
USA:HPRCIC (internal case)

HPRCORG2800W
LID ORGANIZER

HPRCSFD800W SOFT PADDED
OPEN DECK + DIVIDERS USA:
HPRCDK (divider kit)

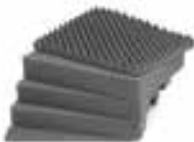

HPRC 3500



TECHNICAL FEATURES

Dimension:

internal dimension 433x319x169(mm) - 17.05x12.56x6.65(in)
external dimension 498x370x185(mm) - 19.61x14.57x7.28(in)



lid: 72(mm) - 2.83(in) bottom: 97(mm) - 3.81(in)

Weight:

empty: 3,00kg - 6.61lbs
with cubed foam: 3,55kg - 7.82lbs



Temperature rating:

Minimum -40°C -40°F Maximum +80°C +176°F

Colors:

Black

TECHNICAL DRAWING

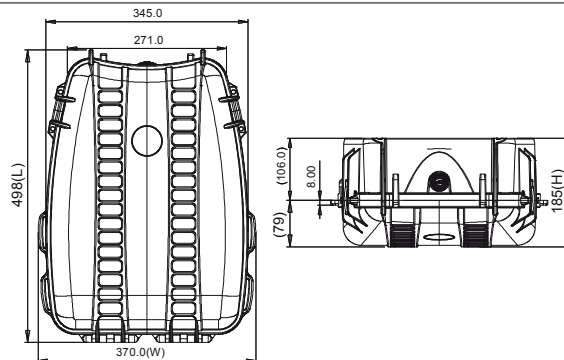

* cubed foam



* interior bag



APPROVALS

ATA 300
IP67
STANAG 4280
DS 81-41

TEST

DROP
IMPACT
HANDLE
WATERTIGHT INTEGRITY
UV COLOR AND MATERIAL
PROTECTION



ACCESSORIES

HPRCCUB3500

CUBED FOAM
USA:HPRCFO (foam only)



HPRCBAG3500

INTERIOR BAG
USA:HPRCIC (internal case)



HPRCORG3500

LID ORGANIZER



* open cases images reflect the different HPRC cases internal options

HPRC 3600

NEW



* open cases images reflect the different HPRC cases internal options

TECHNICAL FEATURES

Dimension:

internal dimension 479x354x194(mm) - 18.86x13.94x7.64(in)
external dimension 542x402x220(mm) - 21.34x15.83x8.66(in)

h28.5

lid: 80(mm) - 3.15(in) bottom: 114(mm) - 4.48(in)

Weight:

empty: 3.20kg - 7.05lbs

Temperature rating:

Minimum -40°C -40°F Maximum +80°C +176°F

Colors:

Black

TECHNICAL DRAWING

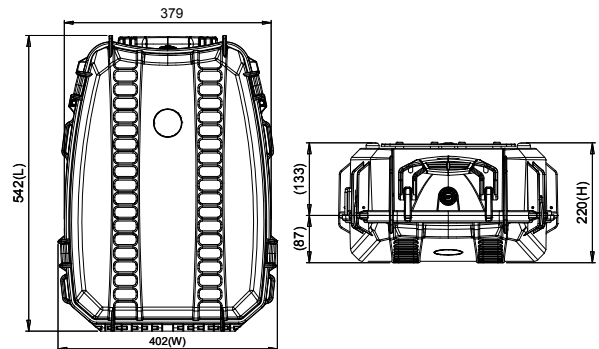

* empty



* cubed foam



* second skin



APPROVALS
ATA 300
IP67
STANAG 4280
DS 81-41

TEST
DROP
IMPACT
HANDLE
WATERTIGHT INTEGRITY
UV COLOR AND MATERIAL
PROTECTION

h volume in litres
W wheeled

ACCESSORIES

HPRCCUB3600
CUBED FOAM
USA:HPRCFO (foam only)



HPRCLO708TSA-1
PADLOCK - TSA



HPRCSSK3600
SECOND SKIN



SECOND SKIN

HPRC 4050

SHOULDER
CASE



TECHNICAL FEATURES

Dimension:

internal dimension 261x171x220(mm) - 10.28x6.73x8.66(in)
external dimension 284x223x260(mm) - 11.18x8.78x10.24(in)

lid: 24(mm) - 0.94(in) bottom: 196(mm) - 7.71(in)

Weight:

empty: 1,66kg - 3.66lbs
with cubed foam: 1,85kg - 4.07lbs

Temperature rating:

Minimum -40°C -40°F Maximum +80°C +176°F

Colors:

Black



TECHNICAL DRAWING

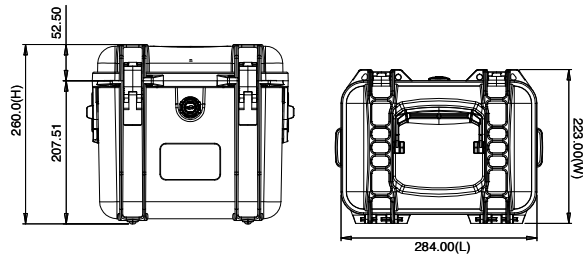

* cubed foam	* soft padded open deck + dividers	APPROVALS ATA 300 IP67 STANAG 4280 DS 81-41	TEST DROP IMPACT HANDLE WATERTIGHT INTEGRITY UV COLOR AND MATERIAL PROTECTION		

ACCESSORIES

HPRCCUB4050 CUBED FOAM USA:HPRCFO (foam only)	HPRCLO708TSA-1 PADLOCK - TSA	HPRCPADDEDSTRAP	HPRCSFD4050 SOFT PADDED OPEN DECK + DIVIDERS USA: HPRCDK (divider kit)	HPRCPANELFRAME SUPPORT KIT	

* open cases images reflect the different HPRC cases internal options

SHOULDER
CASE



* open cases images reflect the different HPRC cases internal options

TECHNICAL FEATURES

Dimension:

internal dimension 401x231x231(mm) - 15.79x9.09x9.09(in)
external dimension 424x284x276,5(mm) - 16.69x11.18x10.89(in)

lt22

lid: 46(mm) - 1.81(in) bottom: 185(mm) - 7.28(in)

Weight:

empty: 2,78kg - 6.13lbs
with cubed foam: 3,27kg - 7.20lbs



Temperature rating:

Minimum -40°C -40°F Maximum +80°C +176°F

Colors:

Black

TECHNICAL DRAWING

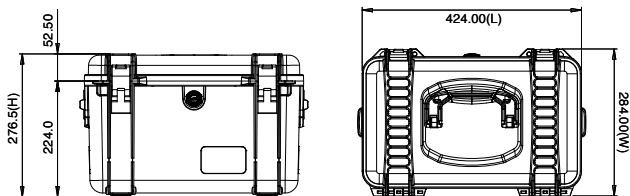

<p>* cubed foam</p>	<p>* soft padded open deck + dividers</p>	<p>APPROVALS ATA 300 IP67 STANAG 4280 DS 81-41</p> <p>TEST DROP IMPACT HANDLE WATERTIGHT INTEGRITY UV COLOR AND MATERIAL PROTECTION</p> <p>lt volume in litres wheeled</p>

ACCESSORIES

<p>HPRCCUB4100 CUBED FOAM USA:HPRCFO (foam only)</p>	<p>HPRCL0708TSA-1 PADLOCK - TSA</p>	<p>HPRCPADDEDSTRAP</p>	<p>HPRCSFD4100 SOFT PADDED OPEN DECK + DIVIDERS USA: HPRCDK (divider kit)</p>	<p>HPRCPANELFRAME SUPPORT KIT</p>	
---------------------------------------------------------------------	------------------------------------------------	-------------------------------	----------------------------------------------------------------------------------------------	----------------------------------------------	--

HPRC 4200

SHOULDER
CASE



TECHNICAL FEATURES

Dimension:
internal dimension 460x240x400(mm) - 18.11x9.45x15.75(in)
external dimension 483x293x445,5(mm) - 19.02x11.54x17.54(in)

lt44

lid: 66(mm) - 2.60(in) bottom: 334(mm) - 13.14(in)

Weight:
empty: 5,00kg - 11.02lbs
with cubed foam: 6,03kg - 13.29lbs

Temperature rating:
Minimum -40°C -40°F
Maximum +80°C +176°F

Colors:
Black

TECHNICAL DRAWING

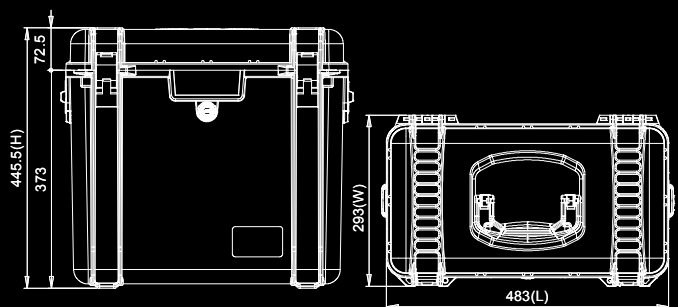

* cubed foam

* interior bag

* soft padded open deck + dividers









APPROVALS
ATA 300
IP67
STANAG 4280
DS 81-41

TEST
DROP
IMPACT
HANDLE
WATERTIGHT INTEGRITY
UV COLOR AND MATERIAL
PROTECTION



ACCESSORIES

<p>HPRCCUB4200 CUBED FOAM USA:HPRCFO (foam only)</p> 	<p>HPRCLO708TSA-1 PADLOCK - TSA</p> 	<p>HPRCCBAG4200 INTERIOR BAG USA:HPRCIC (internal case)</p> 	<p>HPRCPADDEDSTRAP</p> 	<p>HPRCSFD4200 SOFT PADDED OPEN DECK + DIVIDERS USA: HPRCDK (divider kit)</p> 	<p>HPRCPANELFRAME SUPPORT KIT</p> 
---------------------------------------------------------------------------------------------------------------------------------------------------------	------------------------------------------------------------------------------------------------------------------------------------	----------------------------------------------------------------------------------------------------------------------------------------------------------------	-------------------------------------------------------------------------------------------------------------------	-----------------------------------------------------------------------------------------------------------------------------------------------------------------------------------	------------------------------------------------------------------------------------------------------------------------------------

* open cases images reflect the different HPRC cases internal options

* open cases images reflect the different HPRC cases internal options



TECHNICAL FEATURES

Dimension:

internal dimension 585x320x309(mm) - 23.03x12.60x12.17(in)
external dimension 690x380x355(mm) - 27.17x14.96x13.98(in)



lid: 80(mm) - 3.15(in) bottom: 229(mm) - 9.01(in)

Weight:

empty: 6,50kg - 14.33lbs
with cubed foam: 7,96kg - 17.54lbs

Temperature rating:

Minimum -40°C -40°F Maximum +80°C +176°F

Colors:

Black

TECHNICAL DRAWING

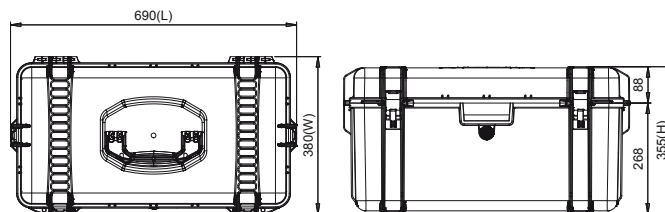

* cubed foam	* interior bag	* soft padded open deck + dividers	APPROVALS ATA 300 IP67 STANAG 4280 DS 81-41
			TEST DROP IMPACT HANDLE WATERTIGHT INTEGRITY UV COLOR AND MATERIAL PROTECTION

ACCESSORIES

HPRCCUB4300
CUBED FOAM
USA:HPRCFO (foam only)



HPRCLO708TSA-1
PADLOCK - TSA



HPRCBAG4300
INTERIOR BAG
USA:HPRCIC (internal case)



HPRCSFD4300 SOFT PADDED
OPEN DECK + DIVIDERS USA:
HPRCDK (divider kit)



HPRC 4300W



TECHNICAL FEATURES

Dimension:

internal dimension 585x320x300(mm) - 23.03x12.60x11.81(in)
external dimension 690x380x358(mm) - 27.17x14.96x14.09(in)

lt62

lid: 80(mm) - 3.15(in) bottom: 220(mm) - 8.66(in)

W

Weight:

empty: 7,30kg - 16.09lbs
with cubed foam: 8,76kg - 19.31lbs

Temperature rating:

Minimum -40°C -40°F Maximum +80°C +176°F

Colors:

Black

TECHNICAL DRAWING

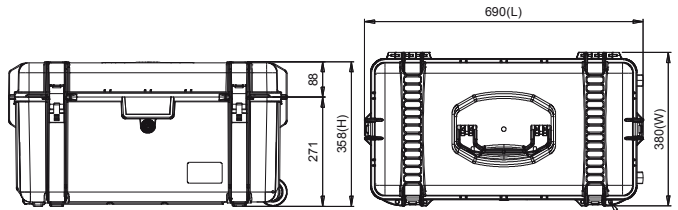

* cubed foam	* interior bag	* soft padded open deck + dividers	APPROVALS ATA 300 IP67 STANAG 4280 DS 81-41	TEST DROP IMPACT HANDLE WATERTIGHT INTEGRITY UV COLOR AND MATERIAL PROTECTION	lt volume in litres wheeled	

ACCESSORIES

HPRCCUB4300W CUBED FOAM USA:HPRCFO (foam only)	HPRCLO708TSA-1 PADLOCK - TSA	HPRCBAG4300W INTERIOR BAG USA:HPRCIC (internal case)	HPRCSFD4300W SOFT PADDED OPEN DECK + DIVIDERS USA: HPRCDK (divider kit)

* open cases images reflect the different HPRC cases internal options

HPRC 4400

* open cases images reflect the different HPRC cases internal options



TECHNICAL FEATURES

Dimension:

internal dimension 420x420x389(mm) - 16.54x16.54x15.31(in)
external dimension 479x481x437(mm) - 18.86x18.94x17.20(in)

lit 74

lid: 65(mm) - 2.56(in) bottom: 324(mm) - 12.75(in)

Weight:

empty: 6,70kg - 14.77lbs
with cubed foam: 8,90kg - 19.62lbs

Temperature rating:

Minimum -40°C -40°F Maximum +80°C +176°F

Colors:

Black

TECHNICAL DRAWING

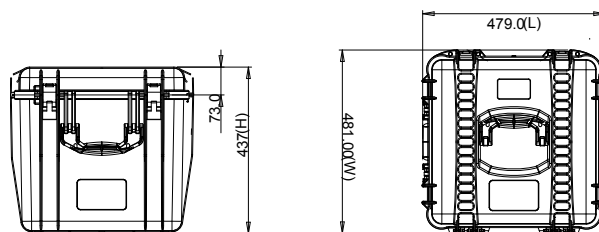

* cubed foam



APPROVALS
ATA 300
IP67
STANAG 4280
DS 81-41

TEST
DROP
IMPACT
HANDLE
WATERTIGHT INTEGRITY
UV COLOR AND MATERIAL
PROTECTION

lit volume in litres
lit wheeled

ACCESSORIES

HPRCCUB4400
CUBED FOAM
USA:HPRCFO (foam only)



HPRCLO708TSA-1
PADLOCK - TSA



HPRCKITW4400
wheel kit for 4400



HPRC 4600W



* open cases images reflect the different HPRC cases internal options

TECHNICAL FEATURES

Dimension:

internal dimension 611x611x375(mm) - 24.05x24.05x14.76(in)
external dimension 670x677x418.5(mm) - 26.38x26.65x16.4(in)



lid: 85.5(mm) - 3.36(in) bottom: 289(mm) - 11.37(in)

Weight:

empty: 10,7kg - 23.54lbs



Temperature rating:

Minimum -40°C -40°F Maximum +80°C +176°F

Colors:

Black

TECHNICAL DRAWING

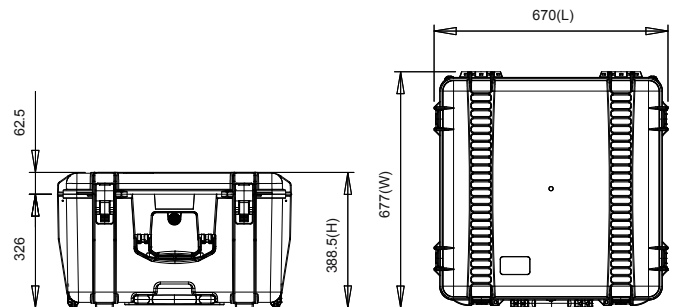

* cubed foam



APPROVALS

ATA 300
IP67
STANAG 4280
DS 81-41

TEST

DROP
IMPACT
HANDLE
WATERTIGHT INTEGRITY
UV COLOR AND MATERIAL
PROTECTION



ACCESSORIES

HPRCCUB4600W
CUBED FOAM
USA:HPRCFO (foam only)



HPRCLO708TSA-1
PADLOCK - TSA





HPRC 4700W



* open cases images reflect the different HPRC cases internal options

TECHNICAL FEATURES

Dimension:

internal dimension 508x301x497(mm) - 20.00x11.85x19.57(in)
external dimension 572x412x564(mm) - 22.52x16.22x22.20(in)

lt81

W

lid: 23(mm) - 0.91(in) bottom: 474(mm) - 18.66(in)

Weight:

empty: 11,60kg - 25.57lbs
with cubed foam: 14,84kg - 32.71lbs

Temperature rating:

Minimum -40°C -40°F Maximum +80°C +176°F

Colors:

Black

TECHNICAL DRAWING

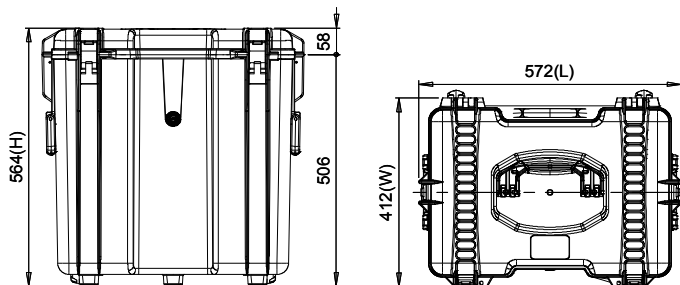

* cubed foam



* interior bag



APPROVALS
ATA 300
IP67
STANAG 4280
DS 81-41

TEST
DROP
IMPACT
HANDLE
WATERTIGHT INTEGRITY
UV COLOR AND MATERIAL
PROTECTION

lt volume in litres
W wheeled

ACCESSORIES

HPRCCUB4700W
CUBED FOAM
USA:HPRCFO (foam only)



HPRCLO708TSA-1
PADLOCK - TSA



HPRCBAG4700W
Interior bag
USA:HPRCIC (internal case)



HPRC 4800W



* open cases images reflect the different HPRC cases internal options

TECHNICAL FEATURES

Dimension:

internal dimension 720x320x600(mm) - 28.34x12.60x23.62(in)
external dimension 776x380x649(mm) - 30.55x14.96x25.55(in)

lid: 60(mm) - 2.36(in) bottom: 540(mm) - 21.25(in)

Weight:

empty: 10,00kg - 22.21lbs
with cubed foam: 14,10kg - 31.08lbs

Temperature rating:

Minimum -40°C -40°F Maximum +80°C +176°F

Colors:

Black



TECHNICAL DRAWING

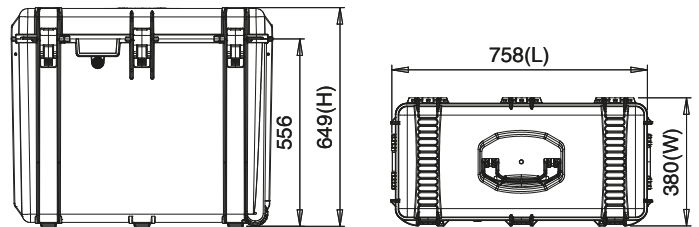

* cubed foam



APPROVALS
ATA 300
IP67
STANAG 4280
DS 81-41

TEST
DROP
IMPACT
HANDLE
WATERTIGHT INTEGRITY
UV COLOR AND MATERIAL
PROTECTION



ACCESSORIES

HPRCCUB4800W
CUBED FOAM
USA:HPRCFO (foam only)



HPRCLO708TSA-1
PADLOCK - TSA



Photo by Phil Arntz



HPRC 5400W

* open cases images reflect the different HPRC cases internal options



TECHNICAL FEATURES

Dimension:

internal dimension 1140x350x160(mm) - 44.88x13.78x6.30(in)
external dimension 1175x410x181(mm) - 46.26x16.14x7.13(in)

lt64

lid: 45(mm) - 1.77(in) bottom: 115(mm) - 4.52(in)

W

Weight:

empty: 7,90kg - 17.42lbs
with cubed foam: 8,80kg - 19.40lbs

Temperature rating:

Minimum -40°C -40°F Maximum +80°C +176°F

Colors:

Black

TECHNICAL DRAWING

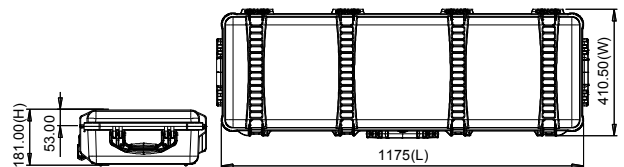

APPROVALS
ATA 300
IP67
STANAG 4280
DS 81-41

TEST
DROP
IMPACT
HANDLE
WATERTIGHT INTEGRITY
UV COLOR AND MATERIAL
PROTECTION

lt64 volume in litres
wheeled

* cubed foam

* interior bag

ACCESSORIES

<p>HPRCCUB5400W CUBED FOAM USA:HPRCFO (foam only)</p>	<p>HPRCLO708TSA-1 PADLOCK - TSA</p>	<p>HPRCBAG5400W INTERIOR BAG USA:HPRCIC (internal case)</p>
		

HPRC 6200



TECHNICAL FEATURES

Dimension:

internal dimension 651x279x243(mm) - 25.63x10.98x9.57(in)
external dimension 700x335x292(mm) - 27.56x13.19x11.50(in)

lt38

lid: 112(mm) - 4.41(in) bottom: 131(mm) - 5.15(in)

Weight:

empty: 4,00kg - 8.82lbs
with cubed foam: 5,80kg - 12.78lbs

Temperature rating:

Minimum Maximum
-40°C -40°F +80°C +176°F

Colors:

Black

TECHNICAL DRAWING

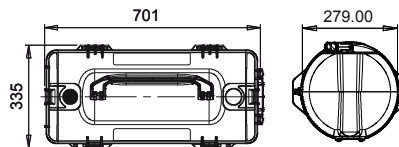

* cubed foam



* tri version



APPROVALS
ATA 300
IP67
STANAG 4280
DS 81-41

TEST
DROP
IMPACT
HANDLE
WATERTIGHT INTEGRITY
UV COLOR AND MATERIAL
PROTECTION



ACCESSORIES

HPRCCUB6200
CUBED FOAM
USA:HPRCFO (foam only)



HPRCTRI6200-02
for tripods



HPRCLO708TSA-1
PADLOCK - TSA



HPRC 6300W

* open cases images reflect the different HPRC cases internal options



TECHNICAL FEATURES

Dimension:

internal dimension 921x279x243(mm) - 36.26x10.98x9.57(in)
external dimension 970x335x285(mm) - 38.19x13.19x11.22(in)



lid: 112(mm) - 4.41(in) bottom: 131(mm) - 5.15(in)

Weight:

empty: 5,70kg - 12.57lbs
with cubed foam: 6,95kg - 15.32lbs

Temperature rating:

Minimum -40°C -40°F Maximum +80°C +176°F

Colors:

Black

TECHNICAL DRAWING

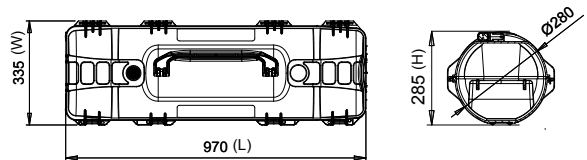

* cubed foam



* tri version



APPROVALS
ATA 300
IP67
STANAG 4280
DS 81-41

TEST
DROP
IMPACT
HANDLE
WATERTIGHT INTEGRITY
UV COLOR AND MATERIAL
PROTECTION



ACCESSORIES

HPRCCUB6300W
CUBED FOAM
USA:HPRCFO (foam only)



HPRCTRIKIT-02
for tripods



HPRCLO708TSA-1
PADLOCK - TSA



HPRC 6400W



* open cases images reflect the different HPRC cases internal options

TECHNICAL FEATURES

Dimension:

internal dimension 1081x279x243(mm) - 42.56x10.98x9.57(in)
external dimension 1128x335x258(mm) - 44.41x13.19x11.22(in)



lid: 112(mm) - 4.41(in) bottom: 131(mm) - 5.15(in)

Weight:

empty: 6,30kg - 13.89lbs
with cubed foam: 7,84kg - 17.28lbs

Temperature rating:

Minimum -40°C -40°F Maximum +80°C +176°F

Colors:

Black

TECHNICAL DRAWING

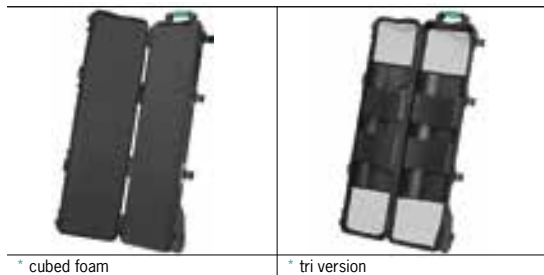
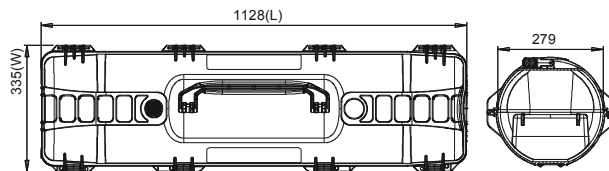

* cubed foam

* tri version



APPROVALS

ATA 300
IP67
STANAG 4280
DS 81-41

TEST

DROP
IMPACT
HANDLE
WATERTIGHT INTEGRITY
UV COLOR AND MATERIAL
PROTECTION



ACCESSORIES

HPRCCUB6400W
CUBED FOAM
USA:HPRCFO (foam only)



HPRCTRIKIT-02
for tripods



HPRCLO708TSA-1
PADLOCK - TSA



HPRC 6500W

* open cases images reflect the different HPRC cases internal options



TECHNICAL FEATURES

Dimension:

internal dimension 1281x279x243(mm) - 50.43x10.98x9.57(in)
external dimension 1330x335x285(mm) - 52.36x13.19x11.22(in)

lt76

lid: 112(mm) - 4.41(in) bottom: 131(mm) - 5.15(in)

W

Weight:

empty: 7,20kg - 15.87lbs
with cubed foam: 9,03kg - 19.90lbs

Temperature rating:

Minimum Maximum
-40°C -40°F +80°C +176°F

Colors:

Black

TECHNICAL DRAWING

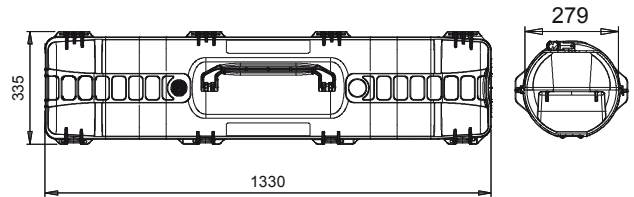

* cubed foam



* tri version



APPROVALS

ATA 300
IP67
STANAG 4280
DS 81-41

TEST

DROP
IMPACT
HANDLE
WATERTIGHT INTEGRITY
UV COLOR AND MATERIAL
PROTECTION

lt volume in litres
W wheeled

ACCESSORIES

HPRCCUB6500W
CUBED FOAM
USA:HPRCFO (foam only)



HPRCTRIKIT-02
for tripods



HPRCLO708TSA-1
PADLOCK - TSA







TECHNICAL FEATURES

Dimension:

closed 394x280x27,5(mm) - 15.51x11.02x1.08(in)
open 464x350x27,5(mm) - 18.26x13.77x1.08(in)

Weight:

empty: 0,95kg - 2.09lbs

Temperature rating:

Minimum Maximum
-40°C -40°F +80°C +176°F

Colors:

Black

TECHNICAL DRAWING

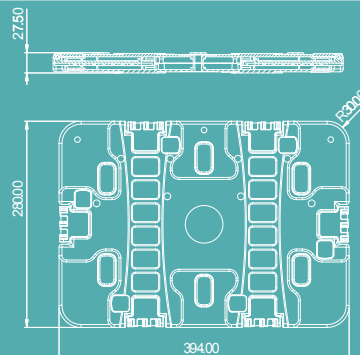

* tripod, laptop and scheller not included



APPROVALS

ATA 300
IP67
STANAG 4280
DS 81-41

TEST

DROP
IMPACT
HANDLE
WATERTIGHT INTEGRITY
UV COLOR AND MATERIAL
PROTECTION

HOW DO YOU LIKE GREY?



HPRC GRAVEL GREY

NOW AVAILABLE IN FOUR DIFFERENT SIZES.

HPRC2550W | HPRC2600W | HPRC2700W | HPRC2745W



technical chart

HPRC1100



internal dimension
57x58x25.5(mm)
2.24x2.28x1.00(in)



external dimension
69x80x32(mm)
2.72x3.15x1.26(in)

weight empty
empty: 0,04kg - 0.09lbs

Colors
Black - Ferrari red

HPRC1300



internal dimension
116x67x25.5(mm)
4.57x2.64x1.00(in)



external dimension
127x90x32(mm)
5.00x3.54x1.26(in)

weight empty
empty: 0,09kg - 0.19lbs

Colors
Black - Ferrari red

HPRC1400



internal dimension
180x110x40(mm)
7.08x4.33x1.57(in)



external dimension
200x142x48(mm)
7.87x5.59x1.88(in)

weight empty
empty: 0.60kg - 1.32lbs

Colors
Black

NEW

HPRC2100



internal dimension
210x145x94(mm)
8.27x5.71x3.70(in)



external dimension
235x196x110(mm)
9.25x7.72x4.33(in)

weight empty
empty: 0,76kg - 1.68lbs

Colors
Black - Orange - Ferrari red -
Electric blue

HPRC2200



internal dimension
236x182x108(mm)
9.29x7.17x4.25(in)



external dimension
258x230x123(mm)
10.16x9.06x4.84(in)

weight empty
empty: 0,87kg - 1.92lbs

Colors
Black

HPRC2250



internal dimension
236x182x155(mm)
9.29x7.17x6.10(in)



external dimension
258x230x170(mm)
10.16x9.06x6.69(in)

weight empty
1,00kg - 2.20lbs

Colors
Black

HPRC2300



internal dimension
304x231x137(mm)
11.97x9.09x5.39(in)



external dimension
335x289x155(mm)
13.19x11.38x6.10(in)

weight empty
1,67kg - 3.68lbs

Colors
Black - Orange - Ferrari red -
Electric blue

HPRC2350



internal dimension
340x235x99(mm)
13.38x9.25x3.90(in)



external dimension
365x290x115(mm)
-14.37x11.42x4.53(in)

weight empty
1.48kg - 3.25lbs

Colors
Black



HPRC2400



internal dimension
380x266x152(mm)
14.96x10.47x5.98(in)



external dimension
405x330x170(mm)
15.94x12.99x6.69(in)

weight empty
2,05kg - 4.52lbs

Colors
Black - Orange - Ferrari red -
Electric blue



HPRC2460



internal dimension
409x306x175(mm)
16.10x12.05x6.89(in)



external dimension
434x371x193(mm)
17.09x14.61x7.60(in)

weight empty
2,60kg - 5.73lbs

Colors
Black

HPRC2500



internal dimension
450x323x175(mm)
17.72x12.72x6.89(in)



external dimension
478x390x194(mm)
18.82x15.35x7.64(in)

weight empty
3,15kg - 6.94lbs

Colors
Black - Orange - Ferrari red -
Electric blue



HPRC2530



internal dimension
513x288x132(mm)
20.20x11.34x5.20(in)







external dimension
540x350x153(mm)
21.26x13.78x6.02(in)

weight empty
3,20kg - 7.05lbs

Colors
Black

HPRC2550W

	<p>internal dimension 513x288x200(mm) 20.19x11.34x7.87(in)</p>
	<p>external dimension 549x346x236(mm) 21.61x13.62x9.29(in)</p>
	<p>weight empty 4,35kg - 9.57lbs</p>
	<p>Colors Black - Orange - Ferrari red - Electric blue Gravel Grey</p>

HPRC2580

	<p>internal dimension 390x310x89(mm) 15.35x12.20x3.50(in)</p>
	<p>external dimension 410x359x110(mm) 16.14x14.13x4.33(in)</p>
	<p>weight empty 2,40kg - 5.29lbs</p>
	<p>Colors Black</p>

HPRC2600

	<p>internal dimension 492x366x202(mm) 19.37x14.41x7.95(in)</p>
	<p>external dimension 555x432x223(mm) 21.85x17.01x8.78(in)</p>
	<p>weight empty 4,25kg - 9.37lbs</p>
	<p>Colors Black - Orange - Ferrari red - Electric blue</p>

HPRC2600W

	<p>internal dimension 482x358x218(mm) 18.98x14.09x8.58(in)</p>
	<p>external dimension 546x423x250(mm) 21.05x16.65x9.84(in)</p>
	<p>weight empty 6,05kg - 13.34lbs</p>
	<p>Colors Black - Orange - Electric blue Gravel Grey</p>



HPRC2700

	<p>internal dimension 555x459x205(mm) 21.85x18.07x8.07(in)</p>
	<p>external dimension 617x525x227(mm) 24.29x20.67x8.94(in)</p>
	<p>weight empty 5,55kg - 12.24lbs</p>
	<p>Colors Black - Orange - Ferrari red</p>

HPRC2700W

	<p>internal dimension 555x459x256(mm) 21.85x18.07x10.08(in)</p>
	<p>external dimension 620x525x280(mm) 24.41x20.67x11.02(in)</p>
	<p>weight empty 8,30kg - 18.30lbs</p>
	<p>Colors Black - Orange - Ferrari red - Gravel Grey</p>



HPRC2710

	<p>internal dimension 555x459x256(mm) 21.85x18.07x10.08(in)</p>
	<p>external dimension 617x525x280(mm) 24.29x20.67x11.02(in)</p>
	<p>weight empty 6.71kg - 14.76lbs</p>
	<p>Colors Black</p>

HPRC2730W



	<p>internal dimension 509x460x316(mm) 20.04x18.11x12.44(in)</p>
	<p>external dimension 620x520x350(mm) 24.41x20.47x13.78(in)</p>
	<p>weight empty 7,55kg - 16.64lbs</p>
	<p>Colors Black</p>

HPRC2745W

	<p>internal dimension 771x401x247(mm) 30.35x15.78x9.72 (in)</p>
	<p>external dimension 822x452x294(mm) 32.36x17.79x11.57 (in)</p>
	<p>weight empty 7.05kg - 15.6lbs</p>
	<p>Colors Black, Gravel Grey</p>

NEW



HPRC2760W

	<p>internal dimension 690x450x300(mm) 27.16x17.71x11.81(in)</p>
	<p>external dimension 750x510x329(mm) 29.53x20.08x12.99(in)</p>
	<p>weight empty 9,20kg - 20.28lbs</p>
	<p>Colors Black</p>

HPRC2780W

	<p>internal dimension 749x525x366(mm) 29.49x20.67x14.41(in)</p>
	<p>external dimension 810x586,5x388(mm) 31.89x23.09x15.28(in)</p>
	<p>weight empty 12,20kg - 26.90lbs</p>
	<p>Colors Black</p>

HPRC2800W

	<p>internal dimension 749x525x455(mm) 29.49x20.67x17.91(in)</p>
	<p>external dimension 810x586,5x479(mm) 31.89x23.09x18.86(in)</p>
	<p>weight empty 13,20kg - 29.10lbs</p>
	<p>Colors Black</p>

technical chart

HPRC3500



internal dimension
433x319x169(mm)
17.05x12.56x6.65(in)



external dimension
498x370x185(mm)
19.61x14.57x7.28(in)

weight empty
3,00kg - 6.61lbs

Colors
Black

HPRC3600



internal dimension
479x354x194(mm)
18.86x13.94x7.64(in)



external dimension
542x402x220(mm)
21.34x15.83x8.66(in)

weight empty
3.20kg - 7.05lbs

Colors
Black

NEW

HPRC4050



internal dimension
261x171x220(mm)
10.28x6.73x8.66(in)



external dimension
284x223x260(mm)
11.18x8.78x10.24(in)

weight empty
3,00kg - 6.61lbs

Colors
Black



HPRC4100



internal dimension
401x231x231(mm)
15.79x9.09x9.09(in)



external dimension
424x284x276,5(mm)
16.69x11.18x10.89(in)

weight empty
2,78kg - 6.13lbs

Colors
Black



HPRC4200



internal dimension
460x240x400(mm)
18.11x9.45x15.75(in)



external dimension
483x293x445,5(mm)
19.02x11.54x17.54(in)

weight empty
5,35kg - 11.79lbs

Colors
Black

HPRC4300



internal dimension
585x320x309(mm)
23.03x12.60x12.17(in)



external dimension
690x380x355(mm)
27.17x14.96x13.98(in)

weight empty
6,50kg - 14.33lbs

Colors
Black

HPRC4300W



internal dimension
585x320x300(mm)
23.03x12.60x11.81(in)



external dimension
690x380x358(mm)
27.17x14.96x14.09(in)

weight empty
7,30kg - 16.09lbs

Colors
Black



HPRC4400



internal dimension
420x420x389(mm)
16.54x16.54x15.31(in)



external dimension
479x481x437(mm)
18.86x18.94x17.20(in)

weight empty
6,70kg - 14.77lbs

Colors
Black

HPRC4600W



internal dimension
611x611x375(mm)
24.05x24.05x14.76(in)



external dimension
670x677x418.5(mm)
26.38x26.65x16.4(in)

weight empty
9,9kg - 21.83lbs

Colors
Black

HPRC4700W



internal dimension
508x301x497(mm)
20.00x11.85x19.57(in)



external dimension
572x412x564(mm)
22.52x16.22x22.20(in)

weight empty
11,60kg - 25.57lbs

Colors
Black



HPRC4800W



internal dimension
720x320x600(mm)
28.34x12.60x23.62(in)



external dimension
776x380x649(mm)
30.55x14.96x25.55(in)

weight empty
10,00kg - 22.21lbs

Colors
Black



HPRC5400W



internal dimension
1140x350x160(mm)
44.88x13.78x6.30(in)



external dimension
1175x410x181(mm)
46.26x16.14x7.13(in)

weight empty
7,90kg - 17.42lbs

Colors
Black



HPRC6200

internal dimension
651x279x243(mm)
25.63x10.98x9.57(in)



external dimension
700x335x292(mm)
27.56x13.19x11.50(in)

weight empty
4,00kg - 8.82lbs

Colors
Black

HPRC6300W

internal dimension
921x279x243(mm)
36.26x10.98x9.57(in)



external dimension
970x335x285(mm)
38.19x13.19x11.22(in)

weight empty
5,70kg - 12.57lbs



Colors
Black

HPRC6400W

internal dimension
1081x279x243(mm)
42.56x10.98x9.57(in)



external dimension
1128x335x258(mm)
44.41x13.19x11.22(in)

weight empty
6,30kg - 13.89lbs



Colors
Black

HPRC6500W

internal dimension
1281x279x243(mm)
50.43x10.98x9.57(in)



external dimension
1330x335x285(mm)
52.36x13.19x11.22(in)

weight empty
7,20kg - 15.87lbs



Colors
Black

HPRC0500

dimension closed
394x280x27,5(mm)
15.51x11.02x1.08(in)

dimension open
464x350x27,5(mm)
18.26x13.77x1.08(in)

weight empty
empty: 0,95kg - 2.09lbs

Colors
Black

Discover all our products

at: www.hprc.it

Plaber S.r.l reserves the right to modify its products at any time and without notice, in order to better their quality and functionality. Therefore, all the information given in this datasheet is to be considered indicative and subject to possible modifications.



Stand by. More to follow.

Grey Charcoal:
more colors, wider offer



more performing compound

Reinforced corners:
high-level protection

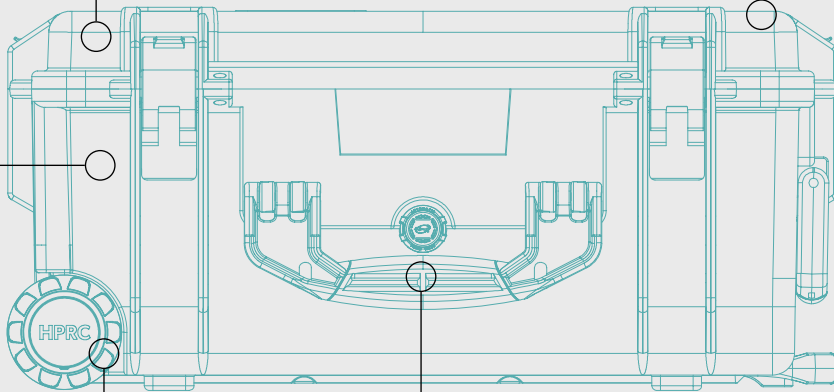

More Wheels available:
depending on where you roll



revolutionary ergonomic handle

SERVICES



Rent a case: Innovative rental solutions for each equipment and situation.



HPRC Bespoke: External shell customization to make your case unique. Create your own.



The Foam Factory: Custom-designed foam inserts, no minimum quantity required.

H P R C C A S E S
MADE IN ITALY
M A N U F A C T U R E D

 Find us
on Facebook

 Plabertalia
Channel



plaber®

Plaber s.r.l.
Via Div Tridentina, 10
I-36061 Bassano del Grappa
Vicenza - Italy

Tel +39 0424 809 150

USA office and warehouse:

Plaber America Inc
240 Anderson Avenue
07074 Moonachie - New Jersey

Tel +1 201 989 3353

www.hprc.it | www.hprcusa.com

info@hprc.it