

plaber®

READY

SPECIAL CASES 2020

We are HPRC. We don't just design and manufacture watertight hard protective cases, we supply carrying solutions. And solutions need to be no-hassle and tailored to your needs.

This is why in Autumn 2013 we designed our first case with a foam specially cut to house the DJI Phantom 1.

Now, almost 6 years later, we are a leading manufacturer of custom cases for drones, gimbals, camcorders and cameras but we feel we are still at the beginning: more is yet to come.

H P R C C A S E S
MADE IN ITALY
MANUFACTURED

HPRC VECTOR PANEL

The new protective layer system designed for your Ready Case



Made of special PVC based compound, the Vector Panel ensures:

- foam long-last durability and integrity;
- improved protection for the equipment;
- dedicated item slots, suitably marked, avoiding lost tools;
- easy and quick organization of the case;
- savings in space and time;
- professional design and presentation.



The system significantly increases the overall performance and efficiency of the case in any kind of environment, weather conditions and temperature.



DJI

SPECIAL CASES 2020

HPRC2710 for DJI Phantom 4 PHA4-2710-01



- 1 DJI Phantom 4 / Pro / 4 Pro + with Props On / 4 V2.0
- 2 Cables / Miscellaneous
- 3 3 x Filters
- 4 Charger + Cables
- 5 2 x Kits of Spare Props
- 6 Spare Battery
- 7 Spare Battery / Miscellaneous Accessories
- 8 Complimentary HPRC1100 for 8 MicroSD Cards
- 9 Ipad Air / Tablet up to 10"
- 10 Controller Monitor Hood for Tablets / Instructions
- 11 Remote Controller
- 12 Cables
- 13 Small Tools

suitable for v 2.0 low noise propellers



Dimension:

internal dimension

555x459x256(mm) - 21.85x18.07x10.08(in)

external dimension

617x525x280(mm) - 24.29x20.67x11.02(in)



lid: 45(mm) - 1.77(in) **bottom:** 211(mm) - 8.30(in)

Weight:

7.75kg - 17.08lbs

Temperature rating:

Minimum
-40°C -40°F

Maximum
+80°C +176°F

HPRC2700W for DJI Phantom 4 PHA4-2700W-01



- 1 DJI Phantom 4 / Phantom 4 Pro / Phantom 4 Pro + with Props On
- 2 Cables / Miscellaneous
- 3 3 x Filters
- 4 Charger + Cables
- 5 2 x Kits of Spare Props
- 6 Spare Battery
- 7 Spare Battery / Miscellaneous Accessories
- 8 Complimentary HPRC1100 for 8 MicroSD Cards
- 9 Ipad Air / Tablet up to 10"
- 10 Controller Monitor Hood for Tablets / Instructions
- 11 Remote Controller
- 12 Cables
- 13 Small Tools



suitable for v 2.0 low noise propellers



Dimension:

internal dimension

555x460x256(mm) - 21.85x18.1x10.08(in)

external dimension

620x525x280(mm) - 24.41x20.67x11.02(in)



lid: 46(mm) - 1,81(in) **bottom:** 210(mm) - 8,27(in)

Weight:

8.72kg - 19.22lbs

Temperature rating:

Minimum
-40°C -40°F

Maximum
+80°C +176°F

Bag for DJI Phantom 4 PHA4-BAG27-01

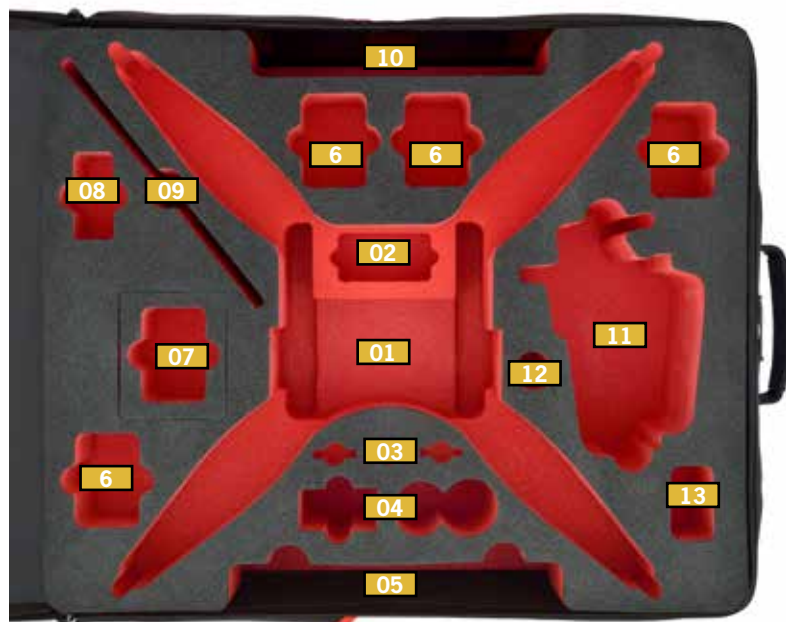

- 01** DJI Phantom 4 / Phantom 4 Pro / Phantom 4 Pro + with Props On
- 02** Cables / Miscellaneous
- 03** 3 x Filters
- 04** Charger + Cables
- 05** 2 x Kits of Spare Props
- 06** Spare Battery
- 07** Spare Battery / Miscellaneous Accessories
- 08** Complimentary HPRC1100 for 8 MicroSD Cards
- 09** Ipad Air / Tablet up to 10"
- 10** Controller Monitor Hood for Tablets / Instructions
- 11** Remote Controller
- 12** Cables
- 13** Small Tools

suitable for v 2.0 low noise propellers



Dimension: external dimension
560x470x235(mm) - 22.05x18.50x9.25(in)

Weight: 2.30kg - 5.07lbs

HPRC2700W for DJI Phantom 4RTK PHA4RTK-2700W-01



- 1 Dji Phantom 4 RTK / Multispectral
- 2 Intelligent Flight Battery
- 3 Remote Controller
- 4 Ipad Air/Tablet Up to 10"
- 5 Hprc1100 For 8 Microsd Cards
- 6 Charging Hub for WB37
- 7 Battery WB37
- 8 Charging Hub for Int.flight Battery
- 9 AC Power Adapter / Miscellaneous Accessories
- 10 Propellers

suitable for v 2.0 low noise propellers

TECHNICAL FEATURES

Dimension:

Internal dimension
550x460x316(mm) - 21.65x18.11x 12.44(in)
External dimension
620x520x350(mm) - 24.41x20.47x13.78(in)

Weight:

9,40 KG – 20.72 lbs

Temperature rating:

Minimum Maximum
-40°C -40°F +80°C +176°F



TECHNICAL DRAWING

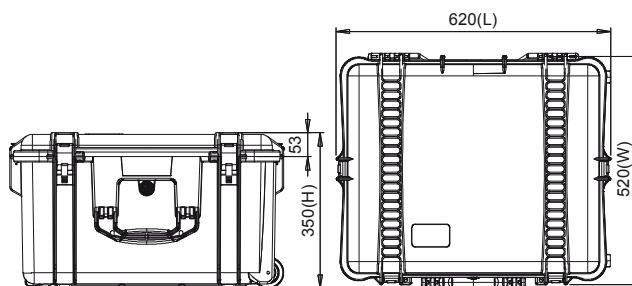

HPRC2780W for DJI Phantom 4 RTK + Ground Station PHA4RTKGS-2780W-01

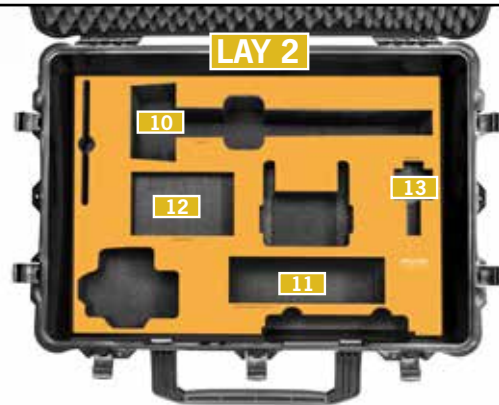
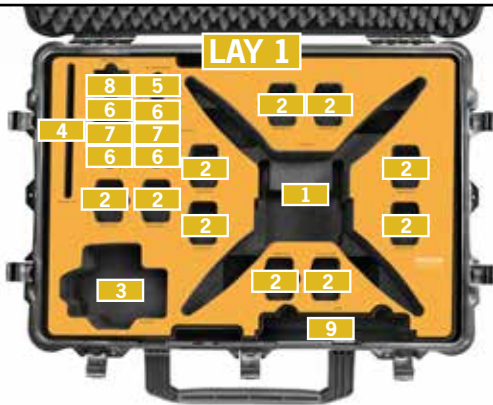

- 1** Dji Phantom 4 RTK / Phantom 4 Multispectral
- 2** Intelligent Flight Battery
- 3** Remote Controller
- 4** Ipad Air/Tablet up to 10"
- 5** Hprc 1100 for 8 MicroSD Card
- 6** Battery WB37
- 7** Charging Hub for WB37
- 8** Miscellaneous Accessories
- 9** Propellers

- 10** D-RTK 2 Body
- 11** Charging Hub for Int.flight Battery/AC Power Adapter
- 12** Miscellaneous Accessories
- 13** Mobile Phone Holder

TECHNICAL FEATURES

Dimension:

Internal dimension
749x525x366(mm) - 29.49x20.67x14.41(in)
External dimension
810x586,5x388(mm) - 31.89x23.09x15.28(in)

Weight:

with foam: 14.30kg - 31.52lbs

Temperature rating:

Minimum Maximum
-40°C -40°F +80°C +176°F



TECHNICAL DRAWING

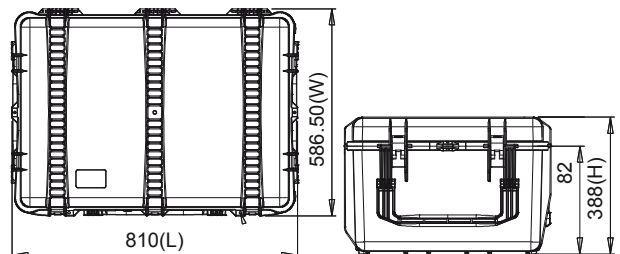

HPRC6500W for DJI D-RTK 2

DRTK6500W-01

dji
D-RTK 2



- 1** D-RTK 2 Body
- 2** Accessories Box (Mobile Phone Holder; Charging Hub, Intelligent Battery, Battery Cover, Ac Power Adapter\Cable etc)
- 3** Extention Rod
- 4** Tripod

HPRC DJI D-RTK 2

TECHNICAL FEATURES

Dimension:

Internal dimension
1281x279x243(mm) - 50.43x10.98x9.57(in)
External dimension
1330x335x285(mm) - 52.36x13.19x11.22(in)

Weight:

7,20kg - 15.87lbs

Temperature rating:

Minimum Maximum
-40°C -40°F +80°C +176°F



TECHNICAL DRAWING

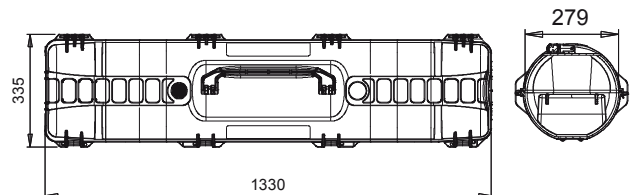



READY

HPRC2780W for DJI Inspire 2 INS2-2780W-02



HPRC DJI INSPIRE 2

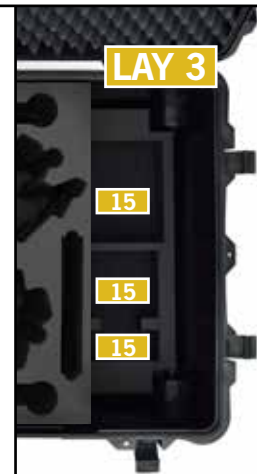
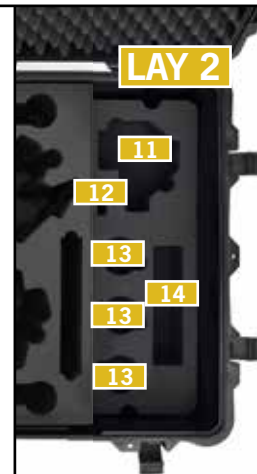
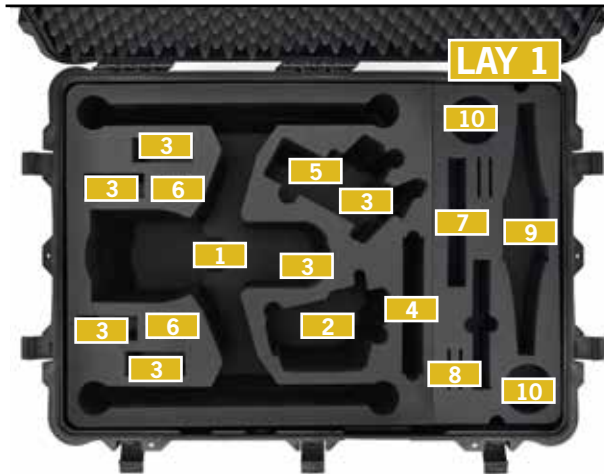

- 1** DJI Inspire 2 in Landing Mode with Gimbal X7 Attached
- 2** Transmitter (Radio Controller)
- 3** Spare Flight Battery
- 4** Crystal Monitor 7.85"
- 5** Cendence Remote Controller
- 6** SSD
- 7** Charger
- 8** Filters
- 9** Props + Spare Props
- 10** Charging Hub

- 11** Gimbal
- 12** Gimbal's Lid
- 13** Lens
- 14** Cables / Miscellaneous

- 15** Miscellaneous / Small Accessories

TECHNICAL FEATURES

Dimension:
 Internal dimension
 749x525x366(mm) - 29.49x20.67x14.41(in)
 External dimension
 810x586,5x388(mm) - 31.89x23.09x15.28(in)

Weight:
 with foam: 14.30kg - 31.52lbs

Temperature rating:
 Minimum Maximum
 -40°C -40°F +80°C +176°F



TECHNICAL DRAWING

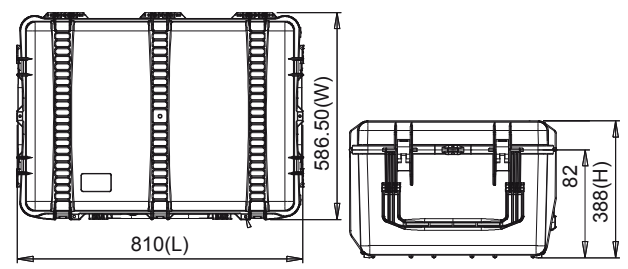

HPRC2550W Battery Case for DJI Inspire 2 BAT-2550W-01



- 1 Battery TB50
- 2 Charger Hub
- 3 Battery Charger
- 4 Miscellaneous



TECHNICAL FEATURES

Dimension:

internal dimension
513x288x200(mm) - 20.19x11.34x7.87(in)
external dimension
549x346x236(mm) - 21.61x13.62x9.29(in)

Weight:

empty: 4.35kg - 9.57lbs

Temperature rating:

Minimum -40°C -40°F
Maximum +80°C +176°F



TECHNICAL DRAWING

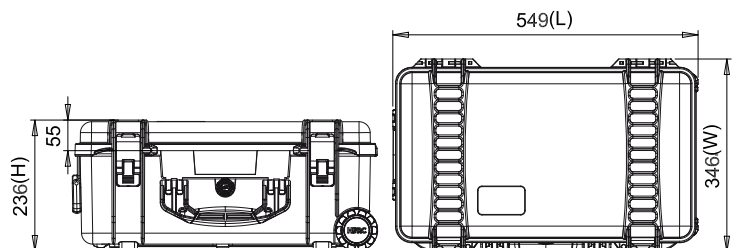

HPRC4600W for DJI Matrice 210/v 2.0

M210-4600W-04



dji
Matrice 210/v 2.0
Landing
Mode



LAY 1

LAY 2



LAY 1



LAY 2

- 1** Dji Matrice 210/v 2.0 with 1 Gimbal Connector, 2 cameras, 2 GPS kit, 2 batteries TB55 mounted
- 2** Cendence Remote Controller
- 3** Cendence Remote Controller
- 4** CrystalSky Battery (WB37)
- 5** Charging Hub for CrystalSky (WCH2)
- 6** CrystalSky 7.85" with sun hood mounted
- 7** Charging Hub (IN2)
- 8** x 1 battery TB55
- 9** Battery Charger
- 10** x 4 Propellers Air

- 11** x 1 battery TB55
- 12** Small Accessories



HPRC DJI MATRICE 210/V 2.0

TECHNICAL FEATURES

Dimension:

internal dimension
611x611x345(mm) - 24.05x24.05x13.58(in)
external dimension
670x677x388.5(mm) - 26.38x26.65x15.3(in)

Weight:

empty: 9,9kg - 21.83lbs

Temperature rating:

Minimum Maximum
-40°C -40°F +80°C +176°F



TECHNICAL DRAWING

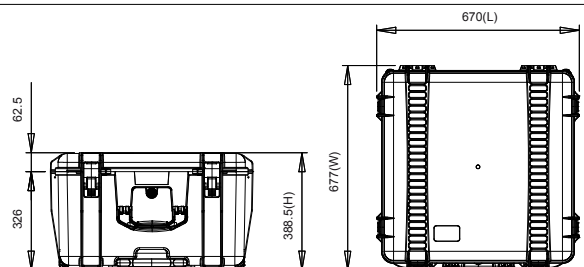

HPRC2550W Battery Case for DJI Matrice 210/v 2.0

BAT-2550W-02



dji
BATTERY CASE
FOR DJI Matrice 210/v 2.0



- 1 Charging Hub
- 2 Battery Charger
- 3 Battery TB50 or TB55
- 4 Charging Hub for CristalSky (WCH2)
- 5 CrystalSky Battery (WB37)



TECHNICAL FEATURES

Dimension:

internal dimension
513x288x200(mm) - 20.19x11.34x7.87(in)
external dimension
549x346x236(mm) - 21.61x13.62x9.29(in)

Weight:

empty: 4.35kg - 9.57lbs

Temperature rating:

Minimum Maximum
-40°C -40°F +80°C +176°F



TECHNICAL DRAWING

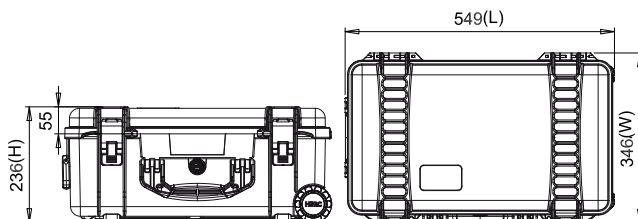

HPRC DJI BATTERY CASES

HPRC2460 for DJI Cendence CEN2460-02



for DJI CENDENCE remote controller



- 1 Cendence Remote Controller
- 2 CrystalSky 7.85"
- 3 Battery Charger
- 4 Charging hub for CrystalSky
- 5 CrystalSky Battery



HPRC DJI CENDENCE

TECHNICAL FEATURES

Dimension:

internal dimension 409x306x175(mm) - 16.10x12.05x6.89(in)
external dimension 434x371x193(mm) - 17.09x14.61x7.60(in)



Weight:

empty: 2,60kg - 5.73lbs
with foam: 3,14kg - 6.92lbs

Temperature rating:

Minimum Maximum
-40°C -40°F +80°C +176°F

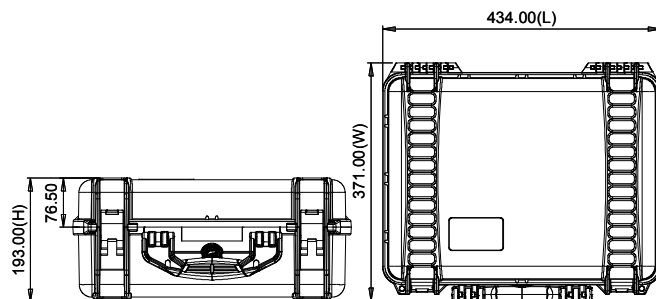

HPRC2400 for DJI Mavic 2

MAV2-2400BLK-02



- 1** Smart Controller/Battery Charger, Cables
- 2** Remote Controller/Battery Charger, Cables
- 3** Battery Charging Hub /Adapter, Various
- 4** DJI Mavic 2 (Intelligent Flight Battery and Gimbal Protector Included)
- 5** Propellers
- 6** Usb Adapter
- 7** Little Accessories
- 8** Usb Power Adapter/cable
- 9** Intelligent Flight Batteries



HPRC DJI MAVIC 2

TECHNICAL FEATURES

Dimension:
 internal dimension
 380x266x152(mm) - 14.96x10.47x5.98(in)
 external dimension
 405x330x170(mm) - 15.94x12.99x6.69(in)

Weight:
 2,38kg - 5.25lbs

Temperature rating:
 Minimum Maximum
 -40°C -40°F +80°C +176°F



TECHNICAL DRAWING

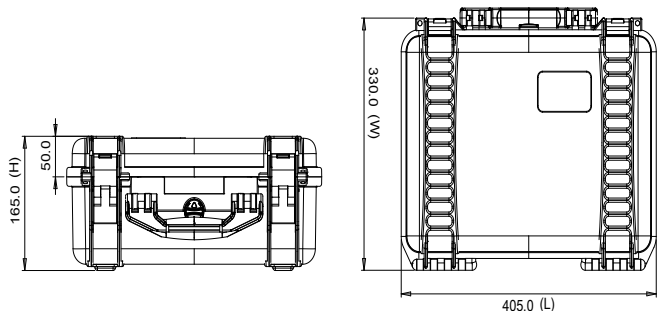

HPRC3500 for DJI Mavic 2

MAV2-3500BLK-02



- 1** DJI Mavic 2 (Intelligent Flight Battery and Gimbal Protector Included)
- 2** Remote Controller/Smart Controller
- 3** Intelligent Flight Batteries
- 4** Usb Power Adapter/cable
- 5** Mavic 2 Car Charger
- 6** Battery Charging Hub /Adapter, Various
- 7** Various / Usb Adaptor
- 8** Cables
- 9** Battery Charging Hub /Adapter, Various

TECHNICAL FEATURES

Dimension:

internal dimension
433x319x169(mm) - 17.05x12.56x6.65(in)
external dimension
498x370x185(mm) - 19.61x14.57x7.28(in)

Weight:

3,55kg - 7.82lbs

Temperature rating:

Minimum Maximum
-40°C -40°F +80°C +176°F



TECHNICAL DRAWING

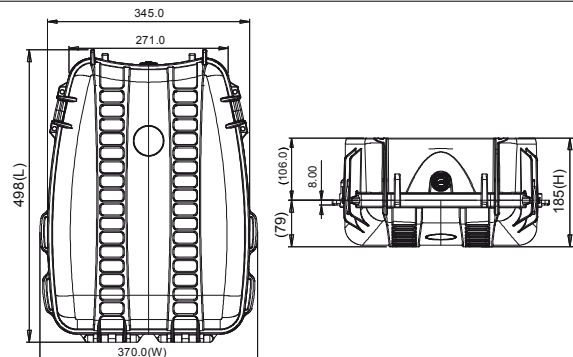

Bag for DJI Mavic 2 MAVBAG35-03



- 1** DJI Mavic 2 (Intelligent Flight Battery and Gimbal Protector Included)
- 2** Remote Controller/Smart Controller
- 3** Intelligent Flight Batteries
- 4** Usb Power Adapter/cable
- 5** Mavic 2 Car Charger
- 6** Battery Charging Hub /Adapter, Various
- 7** Various / Usb Adaptor
- 8** Cables
- 9** Battery Charging Hub /Adapter, Various

TECHNICAL FEATURES

Dimension:
 internal dimension
 433x319x169(mm) - 17.05x12.56x6.65(in)
 external dimension
 498x370x185(mm) - 19.61x14.57x7.28(in)



HPRC2300 for DJI Mavic Mini Fly More Combo MAVM-2300-01



- 1** Aircraft
- 2** Two-Way Charging Hub
- 3** Intelligent Flight Battery
- 4** Pair of Spare Propellers
- 5** DJI 18W USB Charger
- 6** RC/Micro USB Cable
- 7** Remote Controller

(without Propeller Guards)



HPRC DJI MAVIC MINI

TECHNICAL FEATURES

Dimension:

Internal dimension
304x231x137(mm) - 11.97x9.09x5.39(in)
External dimension
335x289x155(mm) - 13.19x11.38x6.10(in)



Weight:

1,90kg - 4.19lbs

Temperature rating:

Minimum Maximum
-40°C -40°F +80°C +176°F

TECHNICAL DRAWING

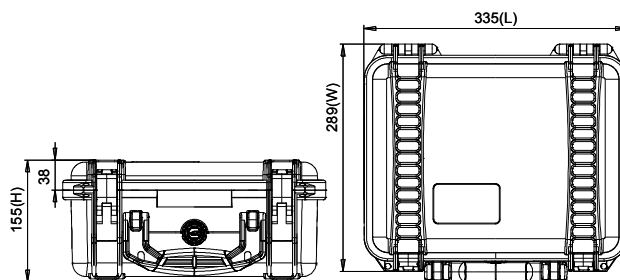



HPRC1400 for DJI OSMO POCKET OSMPKT-1400-01



- 1 DJI Osmo Pocket
- 2 Accessories / Power Cable
- 3 SD Card Rack
- 4 Smartphone adapters

HPRC DJI OSMO POCKET

TECHNICAL FEATURES

Dimension:

internal dimension
180x110x40(mm) - 7,08x4,33x1,57(in)
external dimension
200x142x48(mm) - 7,87x5,59x1,88(in)

Weight:

empty: 0,60kg - 1,32lbs

Temperature rating:

Minimum Maximum
-40°C -40°F +80°C +176°F



TECHNICAL DRAWING

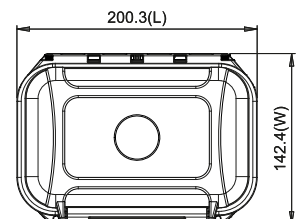
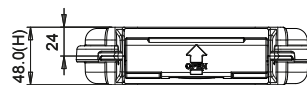

HPRC1400 for DJI OSMO ACTION OSMACT-1400-01



- 1** Osmo Action and Camera Frame
- 2** Battery
- 3** Quick Release Base
- 4** SD Card Rack
- 5** USB-C Cable Flat
- 6** Locking Screw

HPRC DJI OSMO ACTION

TECHNICAL FEATURES

Dimension:

internal dimension
180x110x40(mm) - 7,08x4,33x1,57(in)
external dimension
200x142x48(mm) - 7,87x5,59x1,88(in)

Weight:

empty: 0,60kg - 1,32lbs

Temperature rating:

Minimum Maximum
-40°C -40°F +80°C +176°F



TECHNICAL DRAWING

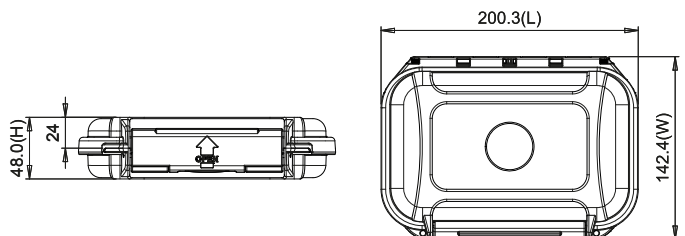

HPRC2460 for DJI Goggles

GGG-2460-01



- 1 Headband
- 2 Dji Goggles Body
- 3 Cables / Miscellaneous Accessories
- 4 Eu Charger
- 5 Uk Charger

HPRC DJI GOGGLES

TECHNICAL FEATURES

Dimension:
 internal dimension 409x306x175(mm) - 16.10x12.05x6.89(in)
 external dimension 434x371x193(mm) - 17.09x14.61x7.60(in)

Weight:
 empty: 2,60kg - 5.73lbs
 with foam: 3,14kg - 6.92lbs

Temperature rating:
 Minimum -40°C -40°F Maximum +80°C +176°F

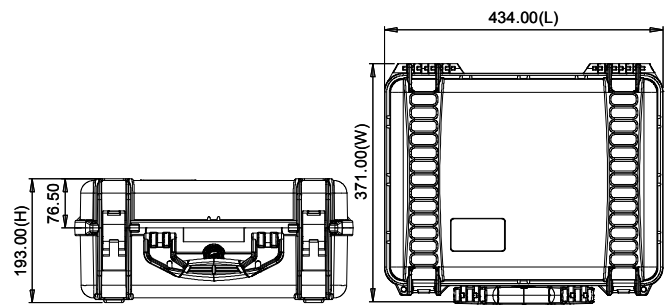

HPRC2500 for DJI Ronin S ROS2500-01



FOR DJI RONIN-S



- 1 Gimbal with Focus Wheel
- 2 Extended Grip/Tripod
- 3 Camera Mounting Plate
- 4 24W Usb Power Adapter
- 5 BG37 Grip x 2
- 6 Accessories Box

TECHNICAL FEATURES

Dimension:

internal dimension 450x323x175(mm) - 17.72x12.72x6.89(in)
external dimension 478x390x194(mm) - 18.82x15.35x7.64(in)

Weight:

3,71kg - 8.18lbs

Temperature rating:

Minimum -40°C -40°F Maximum +80°C +176°F

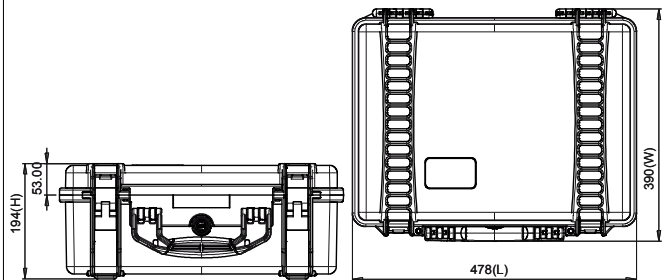

HPRC2550W for DJI Ronin S ROS2550W-01



FOR DJI RONIN-S



- 1 Gimbal with Focus Wheel
- 2 Extended Grip/Tripod
- 3 Camera Mounting Plate
- 4 24W Usb Power Adapter
- 5 BG37 Grip x 3
- 6 Accessories Box
- 7 Lens
- 8 Panasonic Gh5 / Sony Alpha 7 camera body

TECHNICAL FEATURES

Dimension:
 internal dimension
 513x288x200(mm) - 20.19x11.34x7.87(in)
 external dimension
 549x346x236(mm) - 21.61x13.62x9.29(in)

Weight:
 empty: 4.35kg - 9.57lbs

Temperature rating:
 Minimum Maximum
 -40°C -40°F +80°C +176°F



TECHNICAL DRAWING

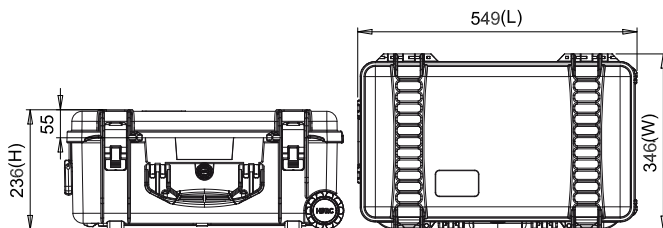

HPRC3500 for DJI Ronin S ROS3500-01



FOR DJI RONIN-S



- 1 Gimbal with Focus Wheel
- 2 Extended Grip/Tripod
- 3 Camera Mounting Plate
- 4 24W Usb Power Adapter
- 5 BG37 Grip x 2
- 6 Accessories Box

TECHNICAL FEATURES

Dimension:

internal dimension
433x319x169(mm) - 17.05x12.56x6.65(in)
external dimension
498x370x185(mm) - 19.61x14.57x7.28(in)

Weight:

3,55kg - 7.82lbs

Temperature rating:

Minimum Maximum
-40°C -40°F +80°C +176°F



TECHNICAL DRAWING

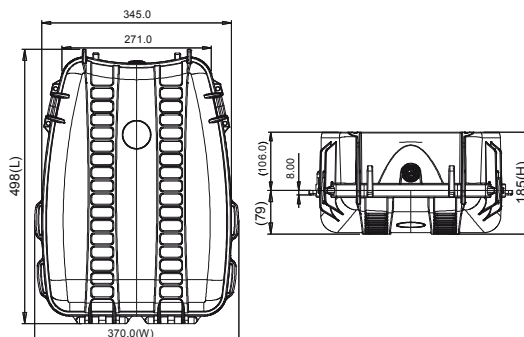

HPRC2500 for DJI Ronin SC

ROSC-2500-01



- 1 DJI Ronin-SC gimbal with BG18 battery grip mounted
- 2 Extended grip mini tripod
- 3 Miscellaneous/cable
- 4 Smartphone holder
- 5 Quick release plate
- 6 Camera riser
- 7 Focus motor
- 8 Focus Motor road Mount

HPRC DJI RONIN SC

TECHNICAL FEATURES

Dimension:

internal dimension 450x323x175(mm) - 17.72x12.72x6.89(in)
 external dimension 478x390x194(mm) - 18.82x15.35x7.64(in)

Weight:

3,71kg - 8.18lbs

Temperature rating:

Minimum -40°C -40°F Maximum +80°C +176°F

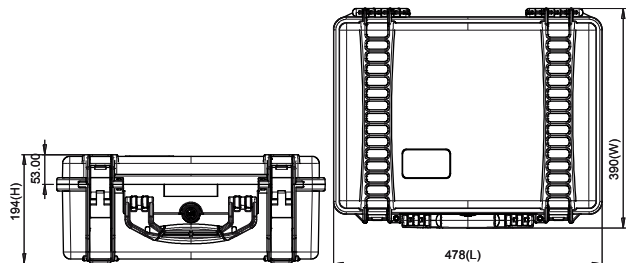

HPRC2730W for DJI Ronin MX RMX2730W-01



- 1 DJI Ronin-MX Transmitter (Controller)
- 2 DJI Ronin-MX Gimbal
- 3 4x Spare Batteries
- 4 2x Charger
- 5 2x Side Handles
- 6 Top Handle Bar
- 7 Tuning Stand
- 8 Camera Mounting Plate

TECHNICAL FEATURES

Dimension:
 internal dimension 509x460x316(mm) - 20.04x18.11x12.44(in)
 external dimension 620x520x350(mm) - 24.41x20.47x13.78(in)

lid: 45(mm) - 1.77(in) bottom: 271(mm) - 10.66(in)

Weight:
 empty: 7,55kg - 16.64lbs
 with cubed foam: 10,43kg - 22.99lbs

Temperature rating:
 Minimum Maximum
 -40°C -40°F +80°C +176°F

Colors:
 Black



TECHNICAL DRAWING

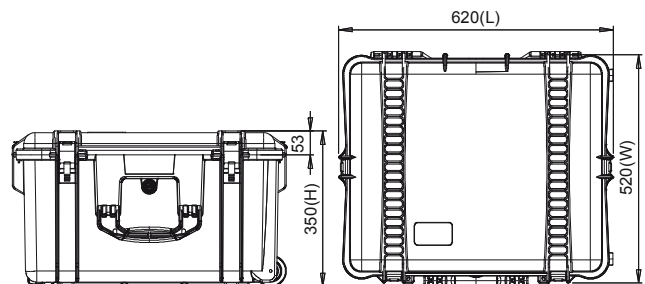

HPRC DJI RONIN-MX



READY

HPRC2700W for DJI Ronin M

ROM2700W-01



- 1** Ronin-M Transmitter (Controller)
- 2** Ronin-M Gimbal
- 3** 2x Side Handles
- 4** Cables/Screws/Small Accessories
- 5** Top Handle Bar
- 6** Cables/Screws/Accessories
- 7** Tuning Stand
- 8** 3x Spare Batteries
- 9** 2x Charger
- 10** Camera Mounting Plate
- 11** 7" Field Monitor



HPRC DJI RONIN-M TRANS.



Dimension:

internal dimension

555x460x256(mm) - 21,85x18,1x10,08(in)

external dimension

620x520x275(mm) - 24,41x20,47x10,83(in)

lid: 46(mm) - 1,81(in) **bottom:** 210(mm) - 8,27(in)

Weight:

empty: 7,55kg - 16,65lbs

with foam: 8,68 KG / 19,14lbs

Temperature rating:

Minimum
-40°C -40°F

Maximum
+80°C +176°F





HPRC 2700W

 READY

HPRC2730W for DJI Robomaster S1 ROB-2730W-01



- 1** Robomaster
- 2** Tablet up to 12,9"
- 3** Charger Cable
- 4** Battery
- 5** Protective Glasses
- 6** Gel Beads Container
- 7** Gel Beads Bottle
- 8** Cup
- 9** Gamepad
- 10** Tape
- 11** Miscellaneous\Small Accessories
- 12** Battery Charger
- 13** Vision Markers (Cardboard Signs)



HPRC DJI ROBOMASTER S1

TECHNICAL FEATURES

Dimension:

internal dimension
509x460x316(mm) - 20.04x18.11x12.44(in)
external dimension
620x520x350(mm) - 24.41x20.47x13.78(in)

Weight:

10,43kg - 22.99lbs

Temperature rating:

Minimum Maximum
-40°C -40°F +80°C +176°F



TECHNICAL DRAWING

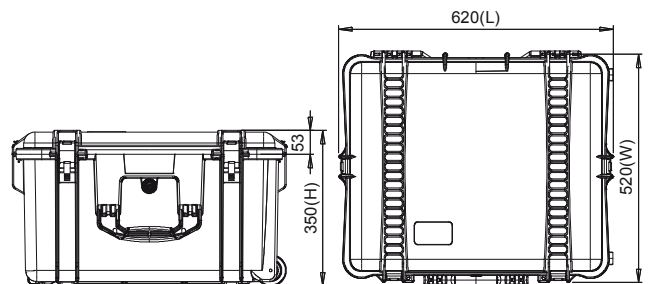



HPRC 2300

ATOMOS



SPECIAL CASES 2020

ATOMOS

HPRC2300 for Atomos Ninja V

NJAV-2300-01



- 1** Ninja Atomos V with AtomX SSD mini and Battery mounted
- 2** Ninja V Sunhood
- 3** Battery
- 4** 12V-3A AC Power Supply
- 5** Cables/Miscellaneous
- 6** 3 Master Caddy II
- 7** Lector docking station USB-C 3.1
- 8** Battery Eliminator
- 9** Power kit Atomos

TECHNICAL FEATURES

Dimension:

Internal dimension
304x231x137(mm) - 11.97x9.09x5.39(in)
External dimension
335x289x155(mm) - 13.19x11.38x6.10(in)

Weight:

1,90kg - 4.19lbs

Temperature rating:

Minimum Maximum
-40°C -40°F +80°C +176°F



TECHNICAL DRAWING

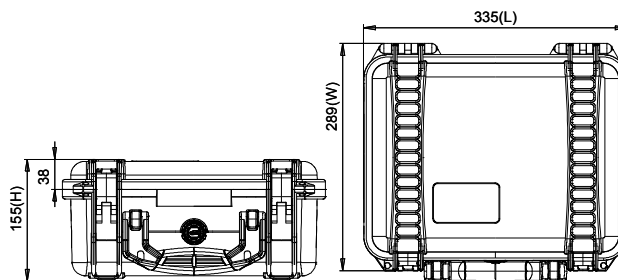





H READY

HPRC2400 Atomos Shogun 7 + Accessory Kit SHG7-2400-01



HPRC ATOMOS SHOGUN 7



- 1 Atomos Shogun 7
- 2 USB 3.0 docking station
- 3 International Adapter
- 4 Cable
- 5 Fast charger
- 6 NP-F750 5200mAh Batteries
- 7 HDR Sunhood
- 8 Master Caddy II drive caddies
- 9 AC Power Adapter
- 10 Miscellaneous Accessories



TECHNICAL FEATURES

Dimension:
 Internal dimension
 380x266x152(mm) - 14.96x10.47x5.98(in)
 External dimension
 405x330x170(mm) - 15.94x12.99x6.69(in)

Weight:
 2,38kg - 5.25lbs

Temperature rating:
 Minimum +80°C +176°F
 Maximum -40°C -40°F



TECHNICAL DRAWING

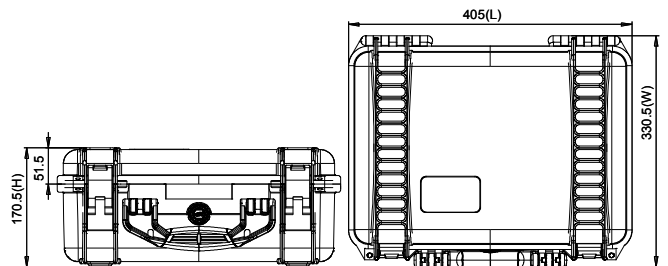



HPHC
2400

SHOGUN

COMPTON

HPRC2730W for Atomos Sumo19

SM19-2730W-01



- 1** Atomos Sumo 19" Monitor Recorder
- 2** Atomos Sunhood

- 3** Charger
- 4** 3 Master caddy II
- 5** DM-130A Gold Mount Mini Battery or similar
- 6** D-4BA Battery Extender or similar

TECHNICAL FEATURES

Dimension:
 internal dimension 509x460x316(mm) - 20.04x18.11x12.44(in)
 external dimension 620x520x350(mm) - 24.41x20.47x13.78(in)
 lid: 45(mm) - 1.77(in) bottom: 271(mm) - 10.66(in)

Weight:
 empty: 7,55kg - 16.64lbs
 with cubed foam: 10,43kg - 22.99lbs

Temperature rating:
 Minimum Maximum
 -40°C -40°F +80°C +176°F

Colors:
 Black

TECHNICAL DRAWING

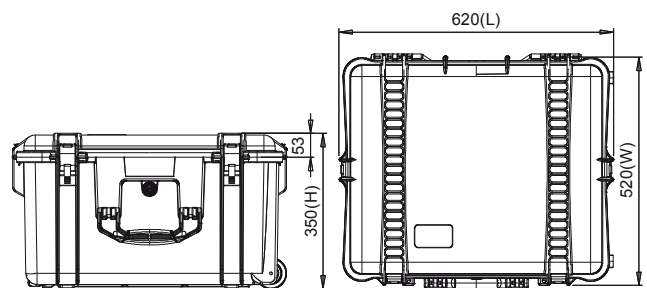



HPRC 2730W

SUM019



MOZA

SPECIAL CASES 2020

HPRC2530 for Moza Air2 Ifocus

MAIR2-2530-01

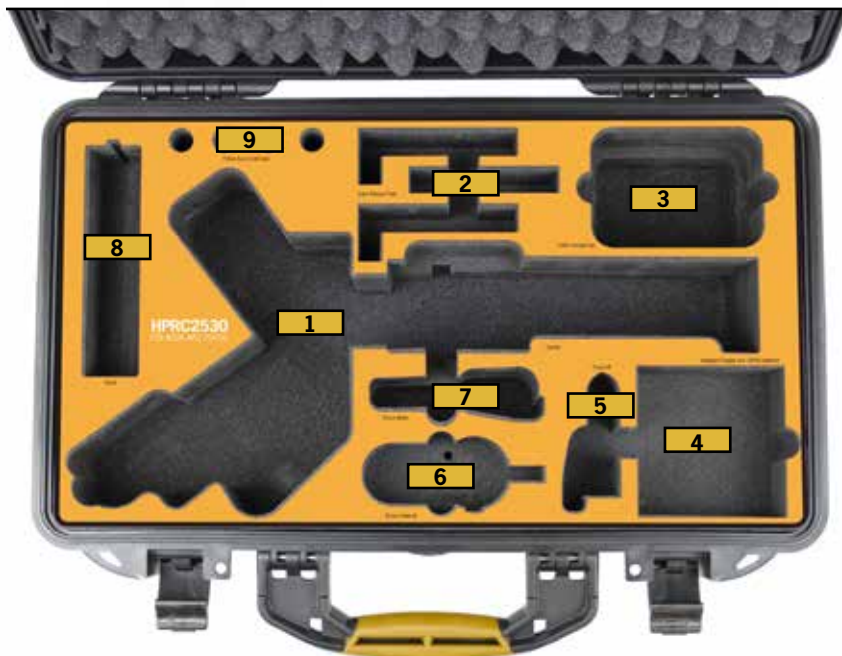

- 1 Gimbal
- 2 Quick Release Plate
- 3 Cable storage bag
- 4 Intelligent Charger and 18650 batteries
- 5 Ifocus M
- 6 Ifocus Handunit
- 7 Ifocus Motor
- 8 Tripod
- 9 Follow focus install pipe



TECHNICAL FEATURES

Dimension:
 internal dimension 513x288x132(mm) - 20.20x11.34x5.20(in)
 external dimension 540x350x153(mm) - 21.26x13.78x6.02(in)

Weight:
 3,26kg - 7.19lbs

Temperature rating:
 Minimum -40°C -40°F Maximum +80°C +176°F

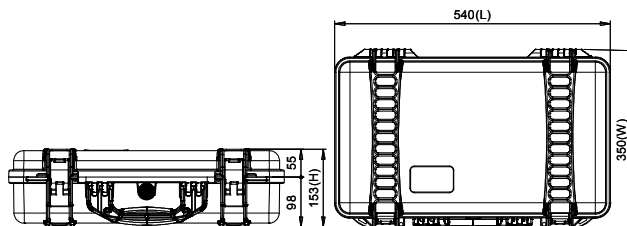

HPRC MOZA AIR2 IFOCUS



ZHIYUN CRANE

SPECIAL CASES 2020

HPRC2600W for ZHIYUN Crane 3 Lab CR3-2600W-01



- 1** Crane 3 Lab Stabilizer
- 2** TransMount Handheld Tripod
- 3** Battery Charger
- 4** Batteries 18650
- 5** Cable Storage Case
- 6** Quick Release Plate
- 7** TransMount Phone Holder



HPRC ZHIYUN CRANE 3 LAB

TECHNICAL FEATURES

Dimension:

Internal dimension
482x358x218(mm) - 18.98x14.09x8.58(in)
External dimension
546x423x250(mm) - 21.05x16.65x9.84(in)

Weight:

6,97kg - 15.37lbs

Temperature rating:

Minimum Maximum
-40°C -40°F +80°C +176°F



W

TECHNICAL DRAWING

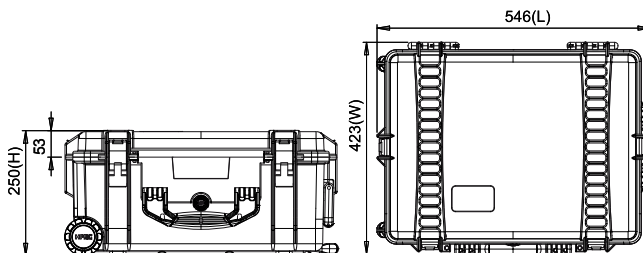

HPRC2700W for ZHIYUN Crane 3 Lab Master package

CR3-2700W-01



- 1** Crane 3 Lab Stabilizer
- 2** Handheld Tripod
- 3** Battery Charger
- 4** Cable Storage Case
- 5** Quick Setup Kits
- 6** Telescopic Monopod with Locking Buckle and Multifunctional Camera Belt
- 7** Phone Holder with Crown Gear
- 8** Miscellaneous
- 9** Batteries 18650
- 10** Focus and Zoom Combo Kits
- 11** Cable
- 12** Quick Release Base Plate
- 13** Quick Release Plate
- 14** HPRC1100 (not included)



TECHNICAL FEATURES

Dimension:

Internal dimension
555x459x256(mm) - 21.85x18.07x10.08(in)
External dimension
620x525x280(mm) - 24.41x20.67x11.02(in)

Weight:

9,07kg - 19.99lbs

Temperature rating:

Minimum Maximum
-40°C -40°F +80°C +176°F

TECHNICAL DRAWING

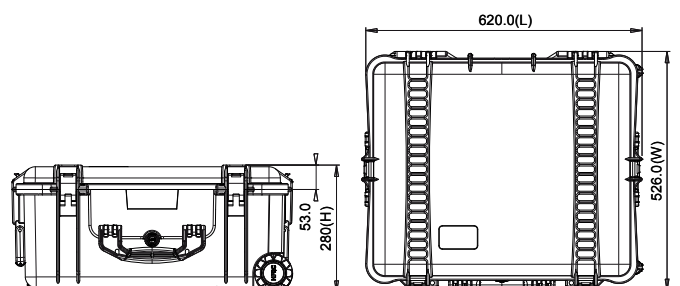



HPRC 2700W

CRANE 3



FREEFLY

SPECIAL CASES 2020

HPRC4600W for Freely Movi Pro

FFS-4600W-02

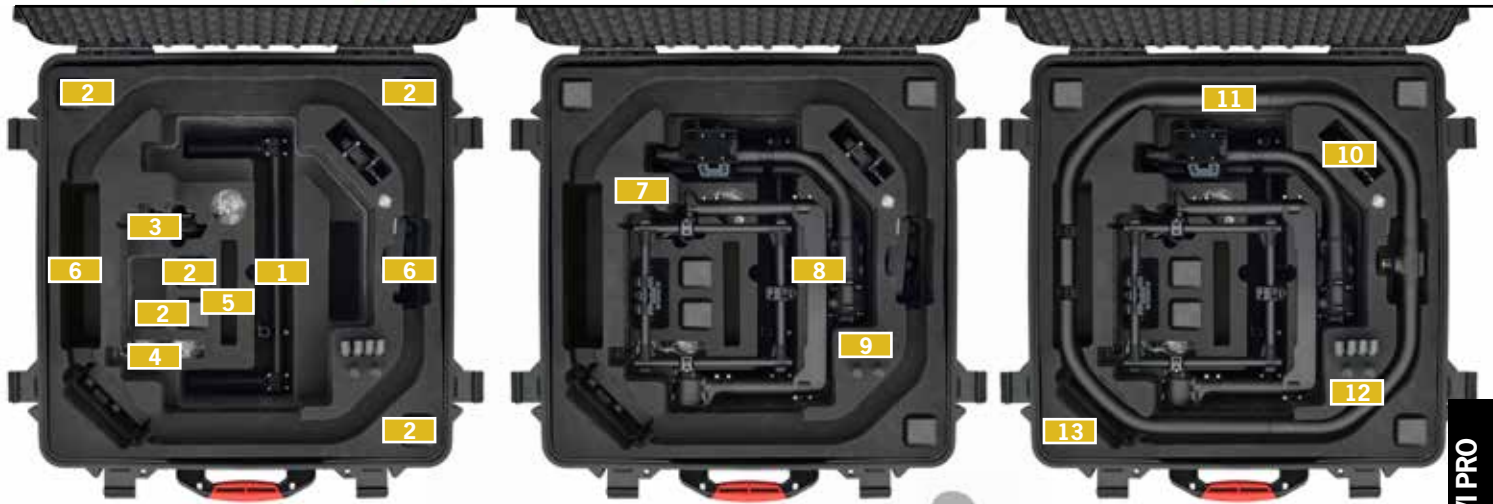

- 1** Mimic / Classic Handle
- 2** Battery
- 3** Mimic Antenna
- 4** Rolls
- 5** Miscellaneous
- 6** MōVI Ring Pro with mounted feet
- 7** Cables
- 8** Main Gimbal
- 9** Plastic rings for MōVI Ring Pro
- 10** MōVI Pro Low Profile Handle
- 11** MōVI Ring Pro with mounted feet
- 12** Freely Hex Driver - 2.0+2.5MM
- 13** Battery Charger



HPRC FREELY MOVI PRO

TECHNICAL FEATURES

Dimension:
 Internal dimension
 611x611x345(mm) - 24.05x24.05x13.58(in)
 External dimension
 670x677x388.5(mm) - 26.38x26.65x15.3(in)

Weight:
 with foam: 14.30kg - 31.52lbs

Temperature rating:
 Minimum Maximum
 -40°C -40°F +80°C +176°F



TECHNICAL DRAWING

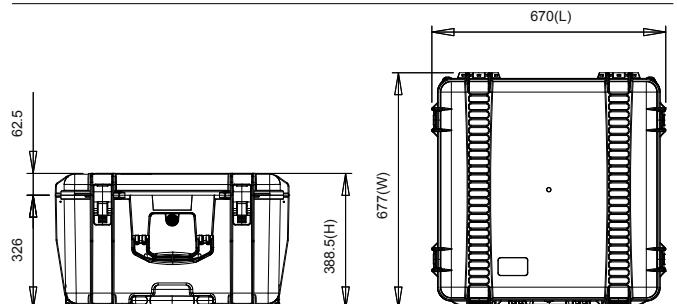



YUNEEC

SPECIAL CASES 2020

HPRC4600W for Yuneec Typhoon H TYH-4600W-01



- 1 Yuneec Typhoon H
- 2 Spare Battery
- 3 Remote Controller
- 4 2 Kits of Spare Props
- 5 Transformer
- 6 Charger
- 7 Miscellaneous Accessories
- 8 Small Accessories / Cables
- 9 Small Tools
- 10 Sunshade



HPRC YUNEEC TYPHOON H

TECHNICAL FEATURES

Dimension:

internal dimension 611x611x345(mm) - 24.05x24.05x13.58(in)
external dimension 670x677x388.5(mm) - 26.38x26.65x15.3(in)

lid: 55.5(mm) - 2.18(in) bottom: 289(mm) - 11.37(in)

Weight:

12,5kg - 27.55lbs

Temperature rating:

Minimum Maximum
-40°C -40°F +80°C +176°F

Colors:

Black



TECHNICAL DRAWING

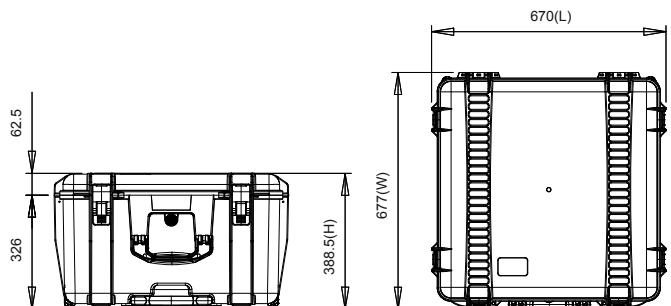



QYSEA

SPECIAL CASES 2020



HPRC2710 for Qysea Fifish V6

FIV6-2710-01



- 1** FIFISH V6 Underwater Robot
- 2** Immersive VR Upgrade
- 3** Remote Controller
- 4** Kevlar Tether, Robot/Control Charger



TECHNICAL FEATURES

Dimension:

Internal dimension
555x459x256(mm) - 21.85x18.07x10.08(in)
External dimension
617x525x280(mm) - 24.29x20.67x11.02(in)

Weight:

6.71kg - 14.76lbs

Temperature rating:

Minimum Maximum
-40°C -40°F +80°C +176°F



TECHNICAL DRAWING

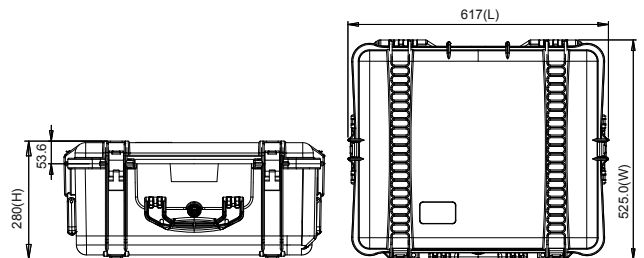



CHASING-INNOVATION

SPECIAL CASES 2020

HPRC2710 for Gladius Mini GLA2710-01



CHASING
INNOVATION
GLADIUS MINI

HPRC
VECTOR PANEL
INSIDE



LAY 1



LAY 2



- 1** 1 Gladius
- 2** 2 Water Cable + Towel
- 3** 3 Buoyancy weight module
- 4** 4 Controller
- 5** 5 Base station
- 6** 6 Ipad/Iphone Remote Bracket
- 7** 7 Charger

TECHNICAL FEATURES

Dimension:

Internal dimension
555x459x256(mm) - 21.85x18.07x10.08(in)
External dimension
617x525x280(mm) - 24.29x20.67x11.02(in)

Weight:

6.71kg - 14.76lbs

Temperature rating:

Minimum Maximum
-40°C -40°F +80°C +176°F



TECHNICAL DRAWING

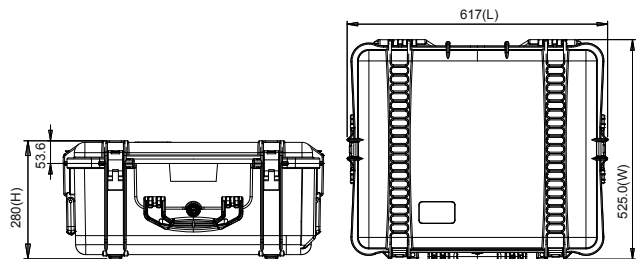



BLACKMAGIC

SPECIAL CASES 2020

HPRC2730W for Blackmagic Ursa Mini Pro/Broadcast

URS2730W-03



Blackmagicdesign **FOR URSA MINI PRO and URSA BROADCAST**



- 1 BlackMagic Ursa Mini Pro / Broadcast with shoulder pad and top handle mounted
- 2 Tripod Plate
- 3 Shoulder Mount kit - Rods clamps
- 4 Batteries
- 5 Lens
- 6 Accessories / Cables
- 7 HPRC1100 Memory card holder for CFast/SDHC cards
- 8 Charger standard and Charger SWIT S-3802S



HPRC BLACKMAGIC URSA MINI PRO

TECHNICAL FEATURES

Dimension:
 internal dimension 509x460x316(mm) - 20.04x18.11x12.44(in)
 external dimension 620x520x350(mm) - 24.41x20.47x13.78(in)
 lid: 45(mm) - 1.77(in) bottom: 271(mm) - 10.66(in)

Weight:
 empty: 7,55kg - 16.64lbs
 with cubed foam: 10,43kg - 22.99lbs

Temperature rating:
 Minimum -40°C -40°F Maximum +80°C +176°F

Colors:
 Black



TECHNICAL DRAWING

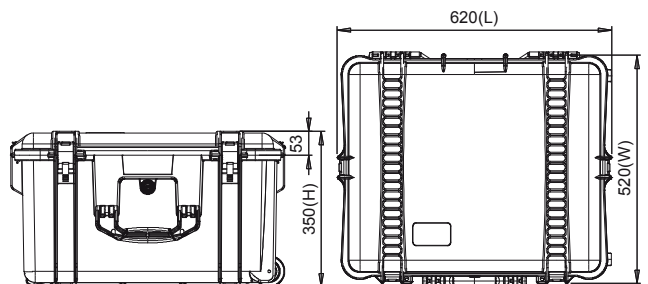

HPRC2400 for BLACKMAGIC Pocket 6K + Metabones

PKT6-2400-01



- 1** Cinema Blackmagic Pocket 6K with or without professional cage and Metabones mounted
- 2** Lenses: Diameter Max 90mm x Length Max 220mm
- 3** International Adapters
- 4** LP-E6 Battery
- 5** 30W power supply
- 6** HPRC1100MEM

HPRC BLACKMAGIC POCKET 6K

TECHNICAL FEATURES

Dimension:

internal dimension
380x266x152(mm) - 14.96x10.47x5.98(in)
external dimension
405x330x170(mm) - 15.94x12.99x6.69(in)

Weight:

2,38kg - 5.25lbs

Temperature rating:

Minimum Maximum
-40°C -40°F +80°C +176°F



TECHNICAL DRAWING

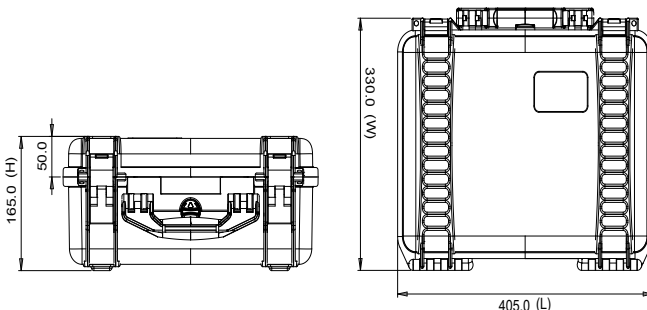

HPRC2400 for Blackmagic Pocket Camera 4K PKT2400-01



- 1 Camera Blackmagic Pocket 4K
- 2 Batteries
- 3 Wise Portable 512 GB
- 4 HPRC1100Mem
- 5 30W Power Supply with international adapters
- 6 International adapters
- 7 Lens: Olympus M. Zuiko Digital ED 12-40mm F28 Pro

HPRC BLACKMAGIC UPOCKET 4K

TECHNICAL FEATURES

Dimension:

internal dimension
380x266x152(mm) - 14.96x10.47x5.98(in)
external dimension
405x330x170(mm) - 15.94x12.99x6.69(in)

Weight:

2,38kg - 5.25lbs

Temperature rating:

Minimum Maximum
-40°C -40°F +80°C +176°F



TECHNICAL DRAWING

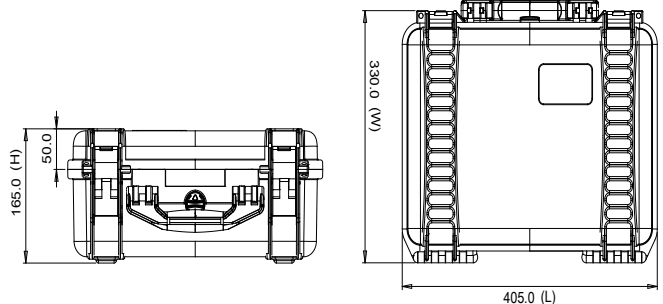

HPRC2710 for Blackmagic Atem 1 M/E ADV1-2710-01

Blackmagicdesign 



1 Blackmagic Design Atem 1 M/E Advanced Panel

HPRC BLACKMAGIC ATEM 1 M/E



Dimension:

internal dimension
555x459x256(mm) - 21.85x18.07x10.08(in)
external dimension
617x525x280(mm) - 24.29x20.67x11.02(in)



lid: 45(mm) - 1.77(in) **bottom:** 211(mm) - 8.30(in)

Weight:

7.75kg - 17.08lbs

Temperature rating:

Minimum
-40°C -40°F

Maximum
+80°C +176°F





GOPRO

SPECIAL CASES 2020

HPRC1400 for GoPro Hero 7

GPR7-1400-01



- 1 GoPro Hero7 with Camera Frame
- 2 Battery
- 3 SD Card Rack
- 4 Cable
- 5 J-Hook Buckle



HPRC GOPRO HERO7

TECHNICAL FEATURES

Dimension:

internal dimension
180x110x40(mm) - 7,08x4,33x1,57(in)
external dimension
200x142x48(mm) - 7,87x5,59x1,88(in)

Weight:

empty: 0,60kg - 1,32lbs

Temperature rating:

Minimum Maximum
-40°C -40°F +80°C +176°F



TECHNICAL DRAWING

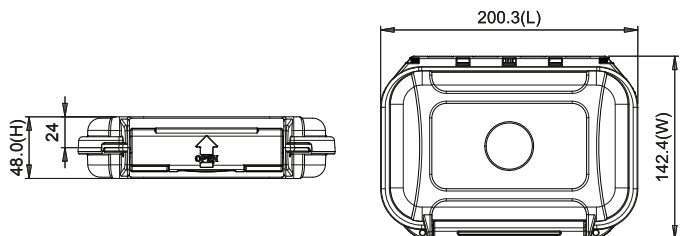



HPRC 2500

FUJIFILM



SPECIAL CASES 2020

HPRC2500 for Fujifilm GFX100

GFX100-2500-01



- 1** Fujifilm GFX100
- 2** Cable storage/Miscellaneous
- 3** Adjustable lens: FUJIFILM GF 110mm f/2 R LM WR Lens, 23mm f/4 R LM WR Lens, 45mm f/2.8 R WR Lens, 32-64mm f/4 R LM WR Lens
- 4** Battery charger
- 5** Battery NP-T125
- 6** Ac Power Adapter

TECHNICAL FEATURES

Dimension:
 internal dimension 450x323x175(mm) - 17.72x12.72x6.89(in)
 external dimension 478x390x194(mm) - 18.82x15.35x7.64(in)

Weight:
 3,71kg - 8.18lbs

Temperature rating:
 Minimum -40°C -40°F Maximum +80°C +176°F

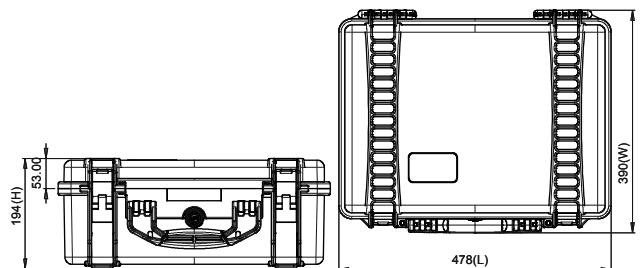



RED

SPECIAL CASES 2020

HPRC2730W for Red Ranger Gemini

RGE-2730W-01



- 1 Camera with Top Handle
- 2 HPRC1300 MEVBLB
- 3 Right Side Wooden Handle 2.0 with R/S Button - Tilt
- 4 Red Mini Mag
- 5 Cable
- 6 Red Bomb EVF DSMC
- 7 Titan Support Arm with Single 1/4" QR Bracket – Monitor Side
- 8 GDU 98Wh Mini V-Lock Battery
- 9 Cable
- 10 BlueShape Travel Charger
- 11 Red Ranger Ac Power Adaptor
- 12 DSMC2 Red Touch 7.0" LCD
- 13 Smallrig for monitor LCD EVF Mount/BMVA/SmallHD, Zacuto Gratical HD1938
- 14 Smallrig Rosette Arm Handle for Shoulder Stabilizer
- 15 Quick Release Platform



HPRC RED RANGER GEMINI

TECHNICAL FEATURES

Dimension:

internal dimension
509x460x316(mm) - 20.04x18.11x12.44(in)
external dimension
620x520x350(mm) - 24.41x20.47x13.78(in)

Weight:

10,43kg - 22.99lbs

Temperature rating:

Minimum Maximum
-40°C -40°F +80°C +176°F



TECHNICAL DRAWING

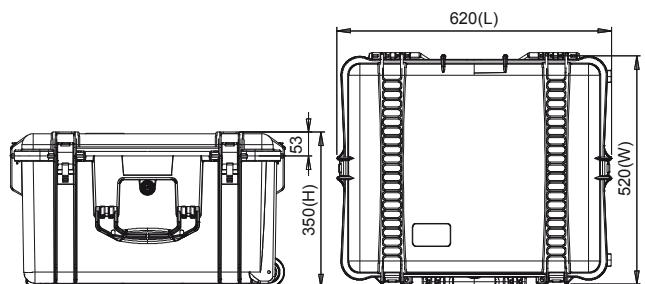



NIKON

SPECIAL CASES 2020

HPRC2460 for Nikon D850

D850-2460-01



for **NIKON D850**



- 1** D850 Camera Body
- 2** Additional EN-EL15a Rechargeable Li-ion Battery
- 3** ME-W1 Wireless Microphone
- 4** ME-1 Stereo Microphone
- 5** Atomos Ninja Flame
- 6** Lenses: AF-S NIKKOR 35mm f/1,8G ED / AF-S NIKKOR 85mm f/1.8G / AF-S NIKKOR 20mm f/1,8G ED
- 7** MH-25A Battery Charger/ UC-E22 USB Cable / Coiled HDMI Cable

HPRC NIKON D850

TECHNICAL FEATURES

Dimension:

internal dimension 409x306x175(mm) - 16.10x12.05x6.89(in)
external dimension 434x371x193(mm) - 17.09x14.61x7.60(in)

Weight:

empty: 2,60kg - 5.73lbs
with foam: 3,14kg - 6.92lbs

Temperature rating:

Minimum Maximum
-40°C -40°F +80°C +176°F

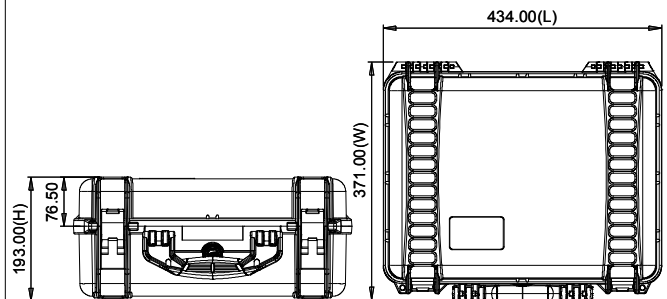



PANASONIC

SPECIAL CASES 2020

HPRC2460 for Panasonic GH5 GH52460-01



FOR PANASONIC GH5

HPRC2460 for PANASONIC GH5 is a special edition, designed to safely carry your GH5 Lumix G Series.



- 1 PANASONIC GH5 with or without professional cage and lenses mounted
- 2 Lenses: LUMIX G 8MM F3,5 (FISHEYE) HD, LUMIX DG SUMMILUX 12 F1.4, LUMIX G PANCAKE 14MM F2,5, LEICA DG SUMMILUX 15mm / F1,7 ASPH, LUMIX G 20MM F1,7 (ASPH), LEICA DG SUMMILUX 25mm F1,4 (ASPH), LUMIX G 25MM F1,7 ASPH., LUMIX G 30MM MACRO F2,8, LEICA DG NOCTICRON 42,5 MM F 1,2 (ASPH) HD, LUMIX G DG 1,7 / 42,5MM ASPH/POWER O.I.S., LEICA DG MACRO-ELMARIT 45MM F2,8 (ASPH), LUMIX G VARIO 7-14MM F4,0 (ASPH) HD, LEICA DG VARIO ELMARIT 8-18, LUMIX G VARIO 12-32MM F3,5-F5,6 (ASPH) HD, LUMIX G X VARIO 12-35MM F2,8 (ASPH) HD, LUMIX G X VARIO 12-35 II, LEICA DG VARIO ELMARIT 12-60, LUMIX G VARIO 12-60, LUMIX G VARIO 14-42MM F3,5-5,6 (ASPH) HD, LUMIX G VARIO 14-42MM F3,5-5,6 (ASPH) HD, LUMIX G X VARIO PZ 14-42MM F3,5-5,6 (ASPH), LUMIX G VARIO 14-45MM F3,5-5,6 (ASPH) HD, LUMIX G X VARIO 35-100MM F2,8 HD, LUMIX G X VARIO 35-100 II, LUMIX G VARIO 35-100MM F4,0-5,6, LUMIX G VARIO 45-200 II, LUMIX G 12,5MM F12,5 3D
- 3 Battery chargers, cables
- 4 Accessories (baseplate, rods, top grip handles, lockports, cables, batteries, controllers, GoPro)
- 5 External recorder Atomos/Sound Device etc

HPRC PANASONIC GH5

TECHNICAL FEATURES

Dimension:

internal dimension 409x306x175(mm) - 16.10x12.05x6.89(in)
external dimension 434x371x193(mm) - 17.09x14.61x7.60(in)

Weight:

3,14kg - 6.92lbs

Temperature rating:

Minimum Maximum
-40°C -40°F +80°C +176°F

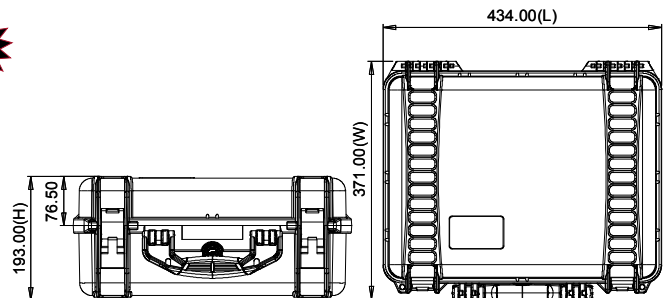



SONY

α
7R

Carl Zeiss

Vario-Tessar FE 4/24-70 ZM AS

3588032

SONY

SPECIAL CASES 2020

HPRC2460 for Sony Alpha 7 ALP2460-01



HPRC2460 for ALPHA 7 is a special edition, designed to safely carry your SONY Alpha Series.



- 1 Sony A7/A7R/A7S/A7II/A7RII/A7SII/a6300 with or without professional cage and lenses mounted (EF/F/PL-Mount/Leica R)
- 2 Lenses: Sony FE 50/1.4, 50/2,8 Macro, 24-70/2.8 G, 85/1,4 G, 16-35/4, 24-70/4, 28-70/3.5-5.6, 28/2.0 - SONY ZA 35/2.8, 35/1.4, 50/1.4, 50/1,8 55/1.8/ 10-18/4 - Zeiss Loxia 21/2.8, 35/2.0, 50/2.0
- 3 Battery chargers, cables
- 4 Accessories (baseplate, rods, top grip handles, lockports, cables, batteries, controllers, GoPro)
- 5 external recorder Atomos/Sound Device etc



TECHNICAL FEATURES

Dimension:
 internal dimension 409x306x175(mm) - 16.10x12.05x6.89(in)
 external dimension 434x371x193(mm) - 17.09x14.61x7.60(in)

Weight:
 3,14kg - 6.92lbs

Temperature rating:
 Minimum Maximum
 -40°C -40°F +80°C +176°F

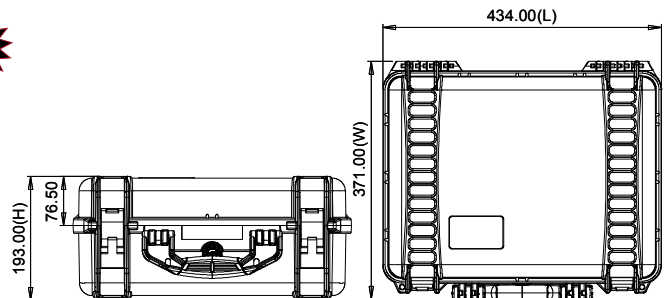

HPRC2600W for Sony PXW-Z280

Z280-2600W-01



- 1** Sony Camcorder PXW-Z280
- 2** Cables/Accessories/Miscellaneous
- 3** Battery Sony BPU – U60
- 4** Compact 4K Wide Conversion
- 5** Microphone



HPRC SONY PXWZ280

TECHNICAL FEATURES

Dimension:

Internal dimension
482x358x218(mm) - 18.98x14.09x8.58(in)
External dimension
546x423x250(mm) - 21.05x16.65x9.84(in)

Weight:

6,97kg - 15.37lbs

Temperature rating:

Minimum Maximum
-40°C -40°F +80°C +176°F



TECHNICAL DRAWING

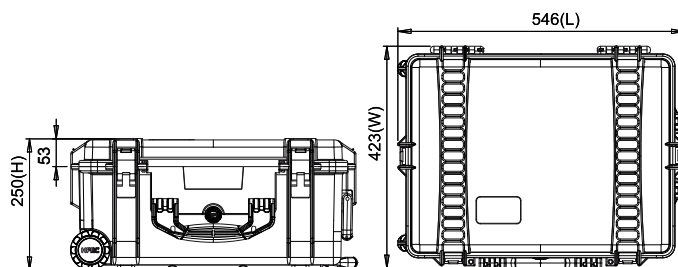

HPRC2700W for Sony PXW-Z190V Z190-2700W-01



SONY
PXWZ190V



- 1** Sony Camcorder PXW-Z190VC
- 2** BC-U1 battery charger
- 3** Battery Sony BPU \Swit S-8U63
- 4** Microphone
- 5** Wireless Audio Set Sony UWP-D11/K51PRO
- 6** Cables/Accessories/Miscellaneous

HPRC SONY PXWZ190V

TECHNICAL FEATURES

Dimension:

Internal dimension
555x459x256(mm) - 21.85x18.07x10.08(in)
External dimension
620x525x280(mm) - 24.41x20.67x11.02(in)

Weight:

9,07kg - 19.99lbs

Temperature rating:

Minimum Maximum
-40°C -40°F +80°C +176°F



TECHNICAL DRAWING

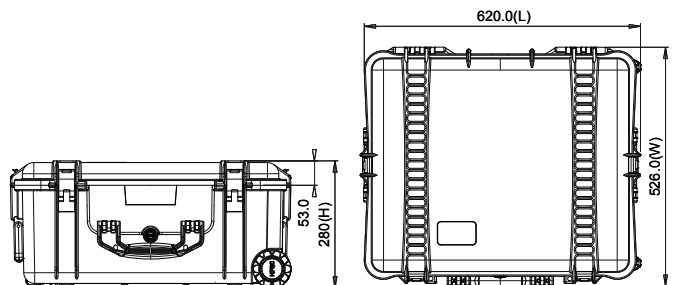

HPRC2730W for Sony PXW-ZFS7 FS7-2730W-01



- 1** Sony PXW-ZFS7
- 2** Viewfinder
- 3** Sony PXW-FS7 FS7 Grip
- 4** HPRC1300 MEMBLB
- 5** VCT-FS7 Lightweight Rod Support System
- 6** 19mm Quick Release
- 7** Miscellaneous
- 8** Rods 9/15/19 mm
- 9** Genlock XDCAFS7
- 10** Charger
- 11** Battery
- 12** Monitor
- 13** Lens 100mm
- 14** Lens 24/70mm
- 15** Box for Metabones PL – E mount T
- 16** Box for Metabones Canon EF Lens to Sony E - mount T



HPRC SONY FS7

TECHNICAL FEATURES

Dimension:

internal dimension
509x460x316(mm) - 20.04x18.11x12.44(in)
external dimension
620x520x350(mm) - 24.41x20.47x13.78(in)

Weight:

10,43kg - 22.99lbs

Temperature rating:

Minimum	Maximum
-40°C -40°F	+80°C +176°F



TECHNICAL DRAWING

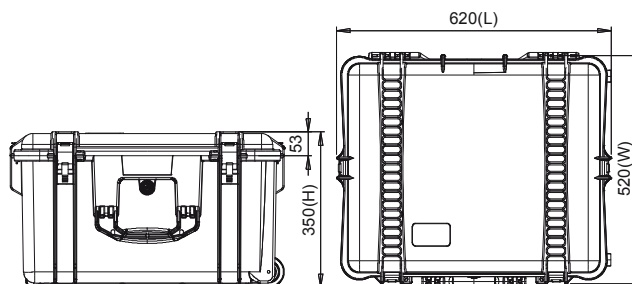

HPRC2730W for Sony Venice

VEN2730W-01



- 1** Sony Venice With Axs-R7 Mounted
- 2** Axs Memory And Sxs Memory Axs-Ar1
- 3** Lanparte Universal Grip Ug-02
- 4** Accessories/Air Evf Mount
- 5** Micellaneous
- 6** Power Supply V-Lock Pc2l
- 7** Battery V-Lock B100usb/B230usb
- 8** Viewfinder Dvf-EI200
- 9** Hprc1300 Sxs
- 10** Shoulder Mount Accessory Vct-Fsa5
- 11** Tripod Place
- 12** Shoulder Mount Rods



TECHNICAL FEATURES

Dimension:

internal dimension 509x460x316(mm) - 20.04x18.11x12.44(in)
 external dimension 620x520x350(mm) - 24.41x20.47x13.78(in)

lid: 45(mm) - 1.77(in) bottom: 271(mm) - 10.66(in)

Weight:

empty: 7,55kg - 16.64lbs
 with cubed foam: 10,43kg - 22.99lbs

Temperature rating:

Minimum Maximum
 -40°C -40°F +80°C +176°F

Colors:

Black



TECHNICAL DRAWING

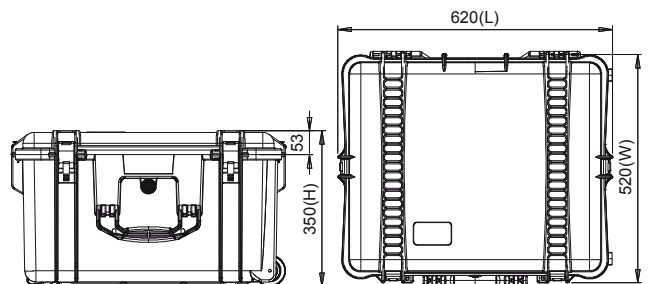

HPRC2700W for Sony PXW-FX9 FX9-2700W-01



SONY
PXW-FX9



- 1 Sony Camcorder
- 2 Viewfinder LCD
- 3 External Microphone
- 4 Battery Sony BP-U Series
- 5 Lens Adapter Metabones
- 6 Sony XQD/SD Card
- 7 Canon CNE Prime Lens
- 8 Cine Lenses up to 105mm Ø
- 9 Photo Lenses up to 105mm Ø
- 10 Hand Grip
- 11 Cable
- 12 Charger
- 13 HPRC1100 MEMBLB

HPRC SONY PXW-FX9

TECHNICAL FEATURES

Dimension:

Internal dimension
555x459x256(mm) - 21.85x18.07x10.08(in)
External dimension
620x525x280(mm) - 24.41x20.67x11.02(in)

Weight:

9,07kg - 19.99lbs

Temperature rating:

Minimum Maximum
-40°C -40°F +80°C +176°F



TECHNICAL DRAWING

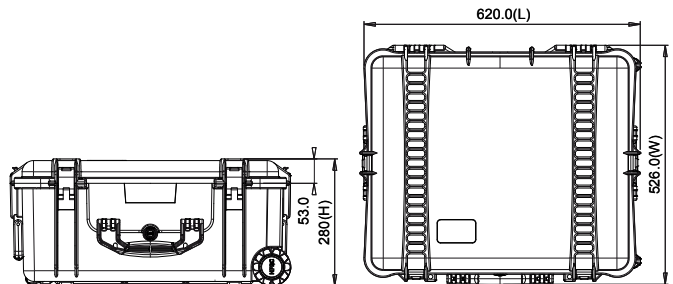

SHOOT WITH NO STRESS WITH THE HPRC2700W FOR SONY PXW-FX9

Organize. Protect. Carry anywhere.





CANON

SPECIAL CASES 2020

HPRC2600 for Canon Eos C100

C100-2600-01



- 1** Canon Eos C100 With Viewfinder and Camera Grip Mounted
- 2** Handle Unit
- 3** Lenses Ef85mm/16-35/24-70/24-105Mm
- 4** Battery Pack Bp 955
- 5** Battery Pack Bp 975
- 6** Battery Charger Cg-940
- 7** Compact Adaptor Ca-941
- 8** Miscellaneous Accessories
- 9** HPRC110Mem

HPRC CANON EOS C100

TECHNICAL FEATURES

Dimension:

internal dimension
482x358x198(mm) - 18.97x14.09x7.79(in)
external dimension
543x419x218(mm) - 21.37x16.49x8.58(in)

Weight:

5,05kg - 11.13lb

Temperature rating:

Minimum Maximum
-40°C -40°F +80°C +176°F



TECHNICAL DRAWING

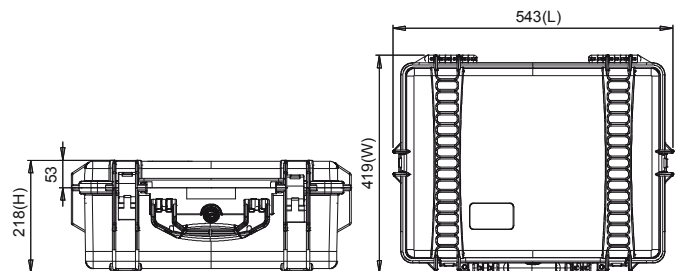

HPRC2600 for Canon Eos C200

C200-2600-01

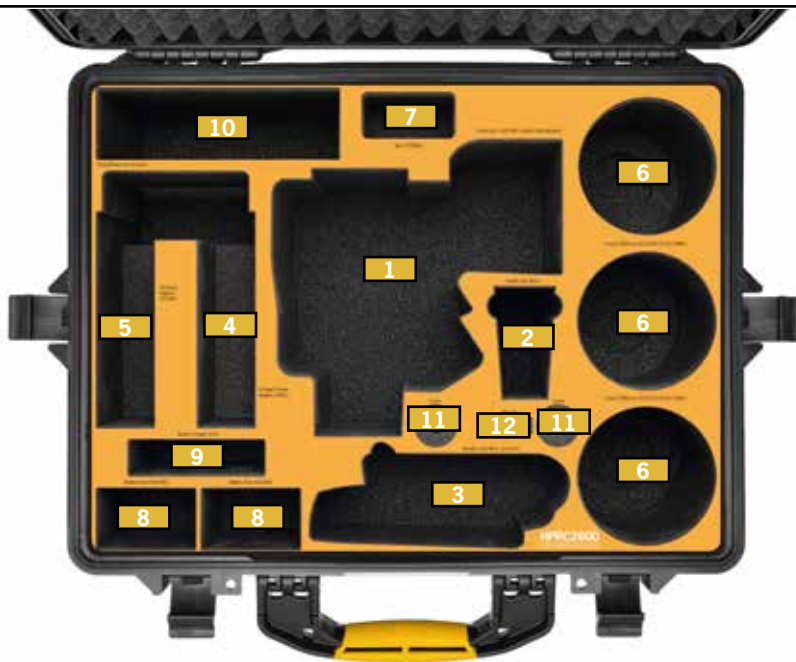

- 1 Canon Eos C200 With Camera Grip Mounted
- 2 Handle Unit Hdu-2
- 3 Monitor Lcd Lm-V1, Lcd La-V1
- 4 Compact Power Adaptor Ca-A10
- 5 Compact Adaptor Cp200b
- 6 Lenses Ef85mm/16-35/24-70/24-105Mm
- 7 Hprc110Mem
- 8 Battery Pack A30/A60
- 9 Battery Charger A-20
- 10 Miscellaneous Accessories
- 11 Screw
- 12 Allen Key

TECHNICAL FEATURES

Dimension:

internal dimension
482x358x198(mm) - 18.97x14.09x7.79(in)
external dimension
543x419x218(mm) - 21.37x16.49x8.58(in)

Weight:

5,05kg - 11.13lb

Temperature rating:

Minimum Maximum
-40°C -40°F +80°C +176°F



TECHNICAL DRAWING

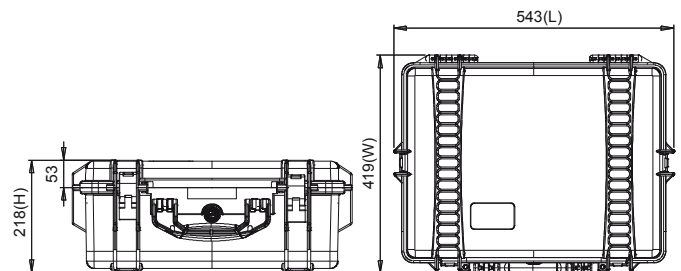





LEICA



LEICA

SPECIAL CASES 2020

SUMMILUX-M 1:1.4/35 ASPH.

HPRC2400 for Leica M LEM2400-01



FOR LEICA M



- 1** 1 x Leica M Camera Body with Lens Attached
- 2** Electronic Viewfinder
- 3** 4 x Lens
- 4** Charger
- 5** Spare Battery
- 6** Cables/Miscellaneous

HPRC LEICA M

TECHNICAL FEATURES

Dimension:
 internal dimension 380x266x152(mm) - 14.96x10.47x5.98(in)
 external dimension 405x330x170(mm) - 15.94x12.99x6.69(in)

Weight:
 empty: 2,05kg - 4.52lbs
 with foam: 2,38kg - 5.25lbs

Temperature rating:
 Minimum -40°C -40°F
 Maximum +80°C +176°F

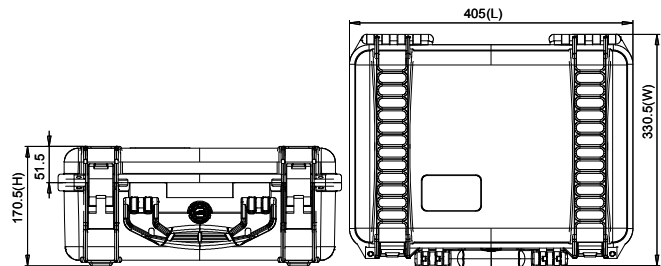

HPRC2460 for Leica M

LEM2460-01



FOR LEICA M



- 1** 2 x Leica M Camera Body with Lens Attached
- 2** 2 x Electronic Viewfinder
- 3** 2 x Spare Batteries
- 4** 4 x Lens
- 5** 2 x Charger
- 6** Cables/Miscellaneous

HPRC LEICA M

TECHNICAL FEATURES

Dimension:

internal dimension 409x306x175(mm) - 16.10x12.05x6.89(in)
 external dimension 434x371x193(mm) - 17.09x14.61x7.60(in)

Weight:

empty: 2,60kg - 5.73lbs
 with foam: 3,14kg - 6.92lbs

Temperature rating:

Minimum -40°C -40°F Maximum +80°C +176°F

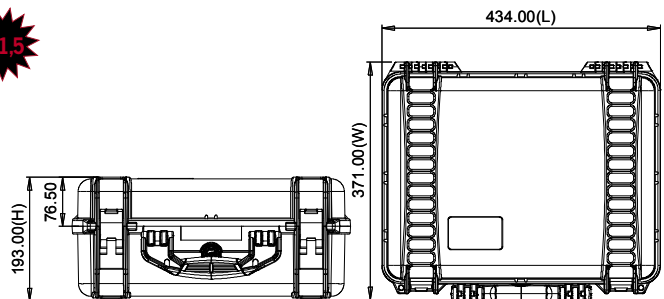



8
11
16

W
*
20





I



BROMPTON

BROMPTON



SPECIAL CASES 2020

HPRC4800W for Brompton BRO4800W-01

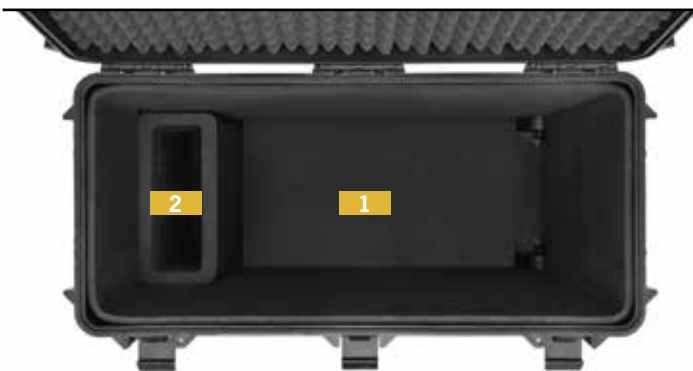

1 Brompton Bike

2 Accessories



HPRC BROMPTON

TECHNICAL FEATURES

Dimension:

internal dimension
720x320x600(mm) - 28.34x12.60x23.62(in)
external dimension
776x380x649(mm) - 30.55x14.96x25.55(in)

Weight:

with foam: 11.60 kg – 25.57 lbs

Temperature rating:

Minimum Maximum
-40°C -40°F +80°C +176°F



W

TECHNICAL DRAWING

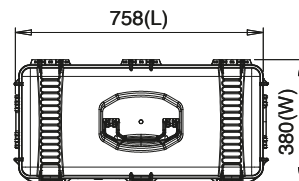
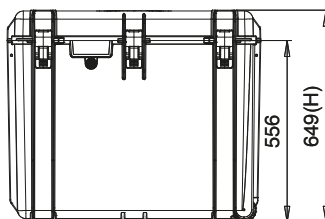



APPLE

SPECIAL CASES 2020

HPRC4800W for Apple IMac 27"

MAC4800W-01



- 1 Apple IMac 27"
- 2 Cable
- 3 Keyboard + Mouse



HPRC APPLE IMAC 27"

TECHNICAL FEATURES

Dimension:

internal dimension
720x320x600(mm) - 28.34x12.60x23.62(in)
external dimension
776x380x649(mm) - 30.55x14.96x25.55(in)

Weight:

with foam: 11.60 kg – 25.57 lbs

Temperature rating:

Minimum Maximum
-40°C -40°F +80°C +176°F



TECHNICAL DRAWING

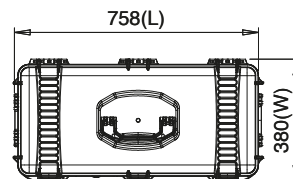
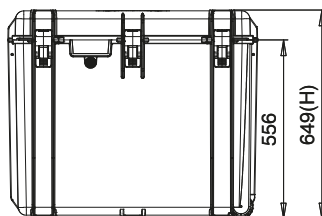

HPRC2350 for MacPro13" + accessories

MPRO-2350-01



- 1** MacBook Pro 13"
- 2** Miscellaneous

HPRC APPLE MACPRO 13"

TECHNICAL FEATURES

Dimension:

internal dimension
340x235x99(mm) - 13.38x9.25x3.90(in)
external dimension
365x290x115(mm) - 14.37x11.42x4.53(in)

Weight:

1.66kg - 3.65lbs

Temperature rating:

Minimum	Maximum
-40°C -40°F	+80°C +176°F



TECHNICAL DRAWING

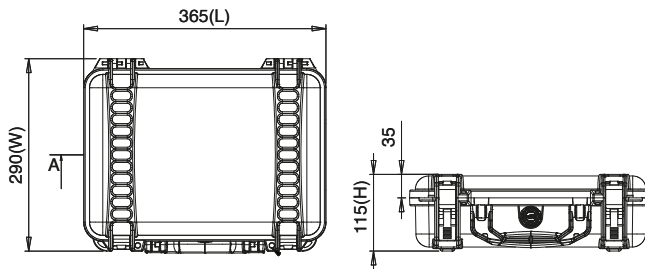

HPRC2400 for MacPro15" + accessories

MPRO-2400-01



- 1** MacBook Pro 15"
- 2** Miscellaneous

TECHNICAL FEATURES

Dimension:

internal dimension
380x266x152(mm) - 14.96x10.47x5.98(in)
external dimension
405x330x170(mm) - 15.94x12.99x6.69(in)

Weight:

2,38kg - 5.25lbs

Temperature rating:

Minimum Maximum
-40°C -40°F +80°C +176°F



TECHNICAL DRAWING

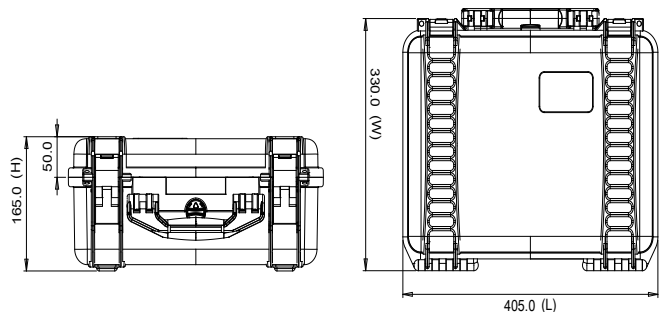



UNIVERSAL MICROPHONES



SPECIAL CASES 2020

HPRC2200 for Universal Microphones

MCF3-2200-01



1 Universal Microphone

TECHNICAL FEATURES

Dimension:

internal dimension
236x182x108(mm) - 9.29x7.17x4.25(in)
external dimension
258x230x123(mm) - 10.16x9.06x4.84(in)

Weight:

1,08kg - 2.38lbs

Temperature rating:

Minimum Maximum
-40°C -40°F +80°C +176°F



TECHNICAL DRAWING

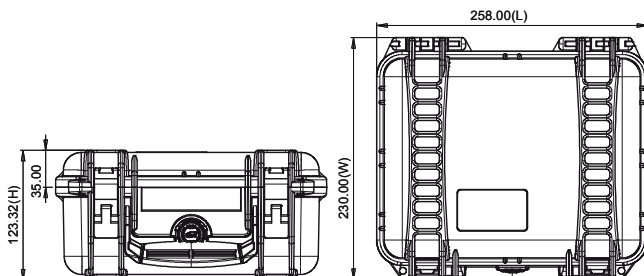

HPRC2250 for Universal Microphones

MCF6-2250-01



LEVEL 1



LEVEL 2



LEVEL 1



LEVEL 2

1 Universal Microphone

TECHNICAL FEATURES

Dimension:

internal dimension
236x182x155(mm) - 9.29x7.17x6.10(in)
external dimension
258x230x170(mm) - 10.16x9.06x6.69(in)

Weight:

1,35kg - 2.97lbs

Temperature rating:

Minimum Maximum
-40°C -40°F +80°C +176°F



TECHNICAL DRAWING

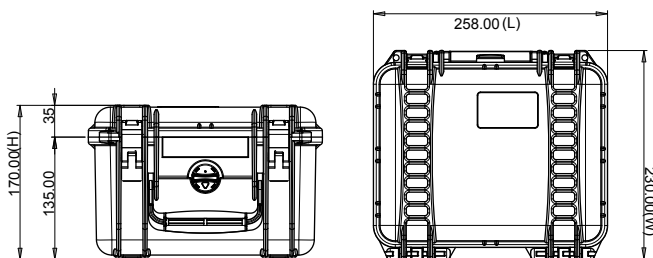





H P R C C A S E S
MADE IN ITALY
M A N U F A C T U R E D





Plaber s.r.l. - HPRC cases

Via Div Tridentina, 10
I-36061 Bassano del Grappa
Vicenza - Italy

Tel +39 0424 809150
Fax +39 0424 808548

USA office and warehouse:

Plaber America Inc - HPRC cases

240 Anderson Avenue
07074 Moonachie - New Jersey

Tel +1 201 617 2010
Fax +1 201 617 2001

www.hprc.it | www.hprcusa.com

info@hprc.it

HPRC® Brand owned by:

plaber
ITALIA

SPECIAL CASES 2020